



Contents

Automotive MOSFETs	3
Small Signal MOSFETs	20
Power MOSFETs	24

Automotive MOSFETs

Infineon automotive MOSFET portfolio offers benchmark quality, wide voltage range and diversified package

- › Best in class $R_{DS(on)}$ performance for increased system efficiency
- › Lowest switching and conduction power losses for increased thermal system reliability
- › Benchmark for quality and reliability
- › Wide voltage range from 24 to 300 V for N-Channel FET, and from 20 to 150 V for P-Channel FET
- › Robust green package for easy process handling
- › Diversified package portfolio caters to customers' needs for
 - Package size minimization (down to 11 mm² in S308)
 - High current capability (up to 300 A in TOLL)

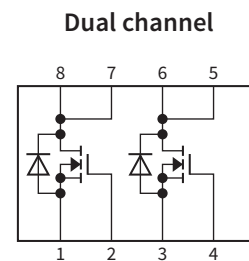
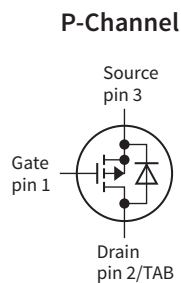
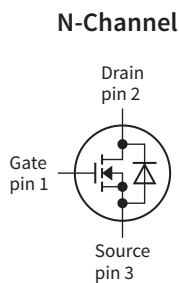

Polarity	Voltage class [V]	Trench MOSFET	Planar MOSFET
N-Channel	24	•	
N-Channel	30	•	•
N-Channel	40	•	•
N-Channel	55	•	•
N-Channel	60	•	•
N-Channel	75	•	•
N-Channel	80	•	
N-Channel	100	•	•
N-Channel	120	•	
N-Channel	150	•	•
N-Channel	200	•	
N-Channel	250	•	
N-Channel	300	•	
P-Channel	20		•
P-Channel	30	•	•
P-Channel	40	•	
P-Channel	55		•
P-Channel	100		•
P-Channel	150		•
Dual N-Channel	2 x 30		•
Dual N-Channel	2 x 40	•	
Dual N-Channel	2 x 50		•
Dual N-Channel	2 x 55		•
Dual N-Channel	2 x 60	•	
Dual N-Channel	2 x 100	•	
Dual P-Channel	2 x 20		•
Dual P-Channel	2 x 30		•
Dual P-Channel	2 x 55		•
Dual N+P channel	2 x 30		•
Dual N+P channel	2 x 55		•

Infineon automotive MOSFET naming system

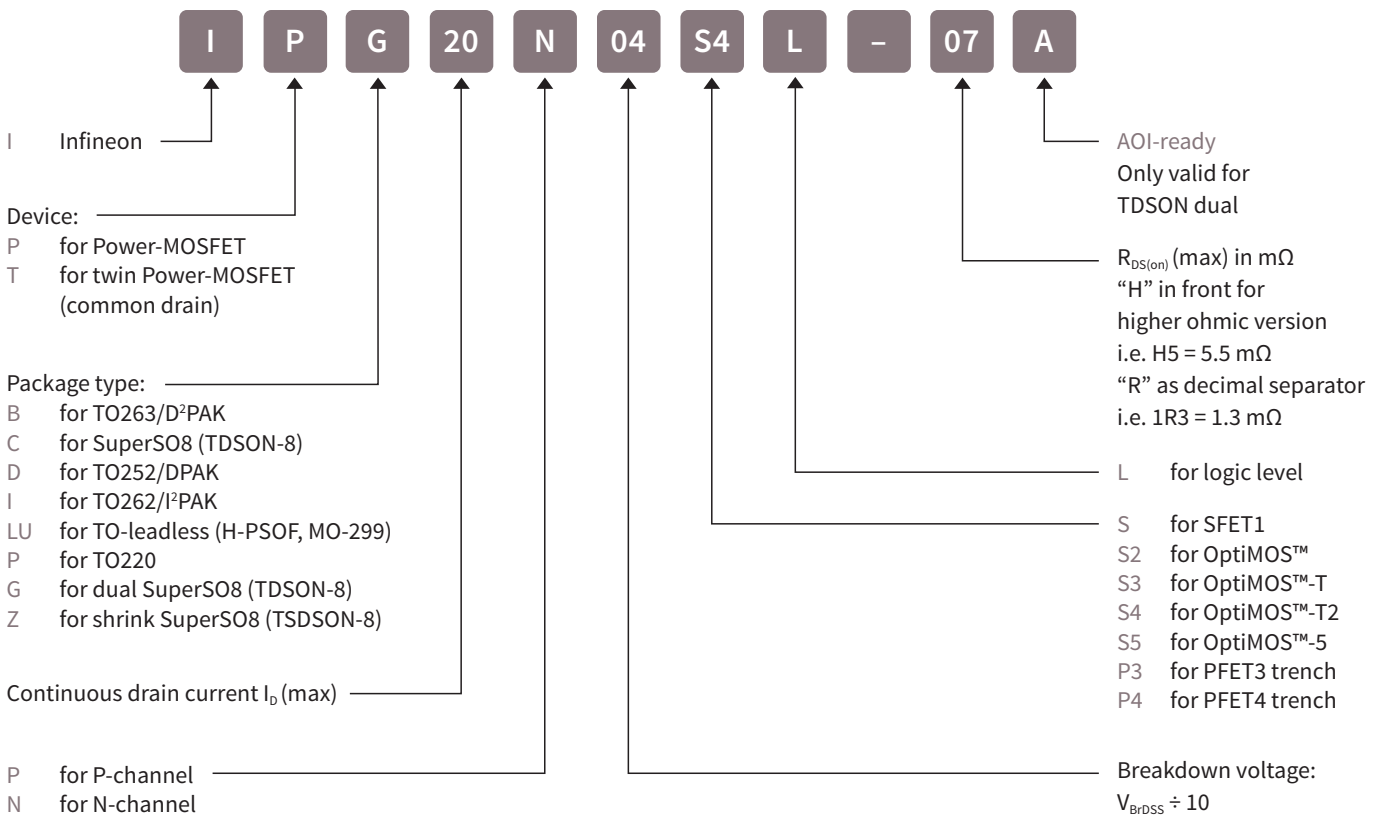

Former IRF COOLiRFET™ naming system

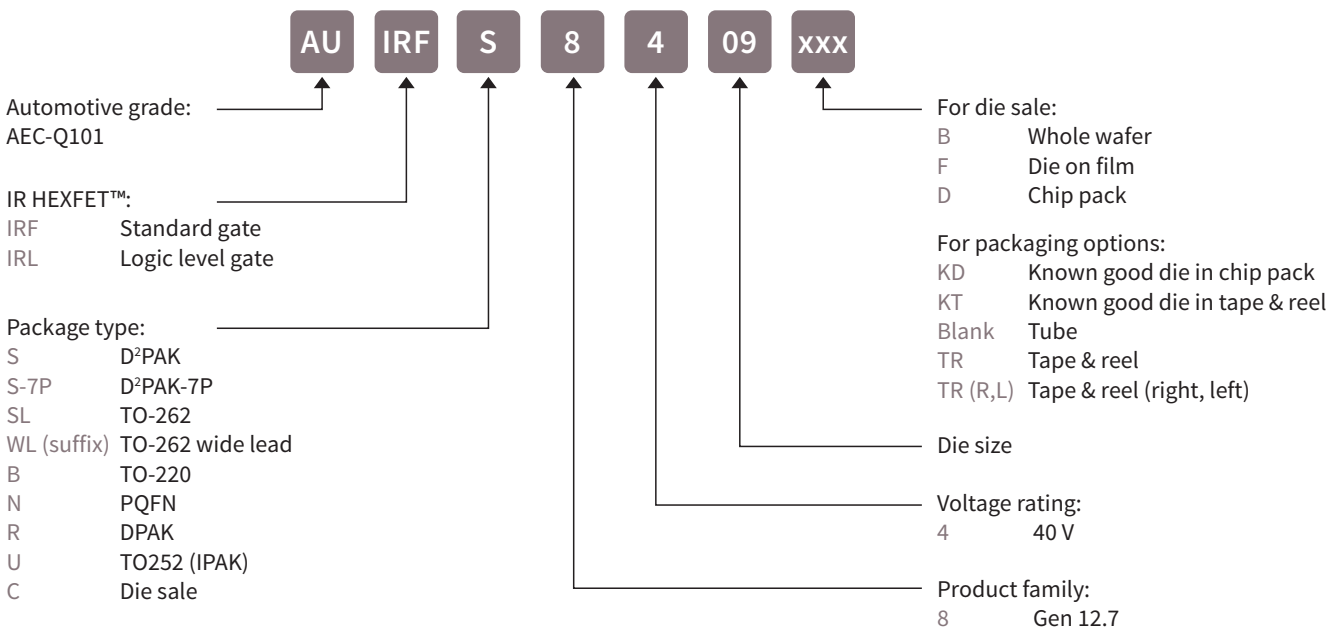

Automotive N-Channel MOSFETs

24 V (Trench)



Product name	Technology	$R_{DS(on)}$ @ 10 V [mΩ]	I_D [A]	R_{thJC} (max) [K/W]	$V_{GS(th)}$ (min-max) [V]	Q_G (typ) [nC]	Normal/ logic level	Package
AUIRF1324S-7P	Gen 10.2	1.00	240	0.50	2.00 ... 4.00	180	Normal	TO-263-7 (D ² PAK 7-leg)
AUIRFP2602	Gen 10.2	1.60	180	0.40	2.00 ... 4.00	260	Normal	TO-247
AUIRF1324WL	Gen 10.2	1.30	240	0.50	2.00 ... 4.00	120	Normal	TO-262 WideLead
AUIRF1324	Gen 10.2	1.50	195	0.50	2.00 ... 4.00	160	Normal	TO-220
AUIRF1324S	Gen 10.2	1.65	195	0.50	2.00 ... 4.00	160	Normal	TO-263-3 (D ² PAK 3-leg)

30 V (Trench)



Product name	Technology	$R_{DS(on)}$ @ 10 V [mΩ]	I_D [A]	R_{thJC} (max) [K/W]	$V_{GS(th)}$ (min-max) [V]	Q_G (typ) [nC]	Normal/ logic level	Package
IPB240N03S4L-R8	OptiMOS™ -T2	0.76	240	0.50	1.00 ... 2.20	290	Logic	TO263-7-3 (TO220-7 (SMD))
IPB240N03S4L-R9	OptiMOS™ -T2	0.92	240	0.70	1.00 ... 2.20	230	Logic	TO263-7-3 (TO220-7 (SMD))
IPB180N03S4L-H0	OptiMOS™ -T2	0.95	180	0.60	1.00 ... 2.20	230	Logic	TO263-7-3 (TO220-7 (SMD))
IPB180N03S4L-01	OptiMOS™ -T2	1.05	180	0.80	1.00 ... 2.20	187	Logic	TO263-7-3 (TO220-7 (SMD))
IPD90N03S4L-02	OptiMOS™ -T2	2.20	90	1.10	1.00 ... 2.20	110	Logic	TO252-3 (DPAK)
IPB80N03S4L-02	OptiMOS™ -T2	2.40	80	1.10	1.00 ... 2.20	110	Logic	TO263-3-2 (TO220-3 (SMD))
AUIRF2903ZL	Gen 10.2	2.40	160	0.65	2.00 ... 4.00	160	Normal	TO-262
AUIRF2903ZS	Gen 10.2	2.40	160	0.65	2.00 ... 4.00	160	Normal	TO-263-3 (D ² PAK 3-leg)
IPI80N03S4L-03	OptiMOS™ -T2	2.70	80	1.10	1.00 ... 2.20	110	Logic	TO262-3
IPP80N03S4L-03	OptiMOS™ -T2	2.70	80	1.10	1.00 ... 2.20	110	Logic	TO220-3
IPB120N03S4L-03	OptiMOS™ -T2	3.00	120	1.90	1.00 ... 2.20	55	Logic	TO263-3-2 (TO220-3 (SMD))
IPD90N03S4L-03	OptiMOS™ -T2	3.30	90	1.60	1.00 ... 2.20	60	Logic	TO252-3 (DPAK)
IPB80N03S4L-03	OptiMOS™ -T2	3.40	80	1.60	1.00 ... 2.20	60	Logic	TO263-3-2 (TO220-3 (SMD))
IPD70N03S4L-04	OptiMOS™ -T2	4.30	70	2.20	1.00 ... 2.20	37	Logic	TO252-3 (DPAK)
IPD50N03S4L-06	OptiMOS™ -T2	5.50	50	2.70	1.00 ... 2.20	24	Logic	TO252-3 (DPAK)
IPD40N03S4L-08	OptiMOS™ -T2	8.00	40	3.60	1.00 ... 2.20	15	Logic	TO252-3 (DPAK)
IPD30N03S4L-09	OptiMOS™ -T2	9.00	30	3.60	1.00 ... 2.20	15	Logic	TO252-3 (DPAK)
IPD30N03S4L-14	OptiMOS™ -T2	13.60	30	4.90	1.00 ... 2.20	11	Logic	TO252-3 (DPAK)
IPB22N03S4L-15	OptiMOS™ -T2	14.60	22	4.90	1.00 ... 2.20	11	Logic	TO263-3-2 (TO220-3 (SMD))

40 V (Trench)



Product name	Technology	$R_{DS(on)}$ @ 10 V [mΩ]	I_D [A]	R_{thJC} (max) [K/W]	$V_{GS(th)}$ (min-max) [V]	Q_G (typ) [nC]	Normal/ logic level	Package
AUIRF7739L2	Gen 12.7	0.60	375	0.44	2.20 ... 3.90	375.00	Normal	DirectFET™2 L8
AUIRFS8409-7P	Gen 12.7	0.69	360	0.40	2.20 ... 3.90	305.00	Normal	TO-263-7 (D ² PAK 7-leg)
AUIRFS8409-7P	Gen 12.7	0.75	240	0.40	1.00 ... 2.40	177.00	Logic	TO-263-7 (D ² PAK 7-leg)
AUIRFS8409-7P	Gen 12.7	0.75	240	0.40	2.20 ... 3.90	305.00	Normal	TO-263-7 (D ² PAK 7-leg)
IPLU300N04S4-R8	OptiMOS™ -T2	0.77	300	0.35	2.00 ... 4.00	221.00	Normal	H5OF-8-1 (H-PSOF)
IPB240N04S4-R9	OptiMOS™ -T2	0.87	240	0.50	2.00 ... 4.00	220.00	Normal	TO263-7-3 (TO220-7 (SMD))
IPB180N04S4-00	OptiMOS™ -T2	0.98	180	0.50	2.00 ... 4.00	220.00	Normal	TO263-7-3 (TO220-7 (SMD))
IPB240N04S4-1R0	OptiMOS™ -T2	1.00	240	0.65	2.00 ... 4.00	170.00	Normal	TO263-7-3 (TO220-7 (SMD))
IPB180N04S4L-H0	OptiMOS™ -T2	1.00	180	0.60	1.20 ... 2.20	239.00	Logic	TO263-7-3 (TO220-7 (SMD))
AUIRF7739L2	Gen 10.7	1.00	270	1.20	2.00 ... 4.00	220.00	Normal	DirectFET™2 L8
AUIRFS8408-7P	Gen 12.7	1.00	240	0.51	2.20 ... 3.90	210.00	Normal	TO263-7-3 (TO220-7 (SMD))

40 V (Trench) (cont'd)



Product name	Technology	$R_{DS(on)}$ @ 10 V [mΩ]	I_D [A]	R_{thJC} (max) [K/W]	$V_{GS(th)}$ (min-max) [V]	Q_G (typ) [nC]	Normal/ logic level	Package
IPB180N04S4-H0	OptiMOS™ -T2	1.10	180	0.60	2.00 ... 4.00	173.00	Normal	TO263-7-3 (TO220-7 (SMD))
IPLU300N04S4-1R1	OptiMOS™ -T2	1.15	300	0.50	2.00 ... 4.00	116.00	Normal	HSOF-8-1 (H-PSOF)
IPB180N04S4L-01	OptiMOS™ -T2	1.20	180	0.80	1.20 ... 2.20	188.00	Logic	TO263-7-3 (TO220-7 (SMD))
AUIRFS8409	Gen 12.7	1.20	195	0.40	2.20 ... 3.90	300.00	Normal	TO-263-3 (D ² PAK 3-leg)
AUIRFSL8409	Gen 12.7	1.20	195	0.40	2.20 ... 3.90	300.00	Normal	TO-262
IPB180N04S4-01	OptiMOS™ -T2	1.30	180	0.80	2.00 ... 4.00	135.00	Normal	TO263-7-3 (TO220-7 (SMD))
AUIRFB8409	Gen 12.7	1.30	195	0.40	2.20 ... 3.90	300.00	Normal	TO-220
AUIRFS8407-7P	Gen 12.7	1.30	240	0.65	2.20 ... 3.90	150.00	Normal	TO-263-7 (D ² PAK 7-leg)
AUIRF3004WL	Gen 10.7	1.40	240	0.40	2.00 ... 4.00	140.00	Normal	TO-262 WideLead
AUIRLS3034-7P	Gen 10.7	1.40	240	0.40	1.00 ... 2.50	120.00	Logic	TO-263-7 (D ² PAK 7-leg)
IPB160N04S4L-H1	OptiMOS™ -T2	1.50	160	0.90	1.20 ... 2.20	146.00	Logic	TO263-7-3 (TO220-7 (SMD))
IPI120N04S4-01	OptiMOS™ -T2	1.50	120	0.80	2.00 ... 4.00	135.00	Normal	TO262-3
IPB120N04S4-01	OptiMOS™ -T2	1.50	120	0.80	2.00 ... 4.00	135.00	Normal	TO263-3-2 (TO220-3 (SMD))
IPB160N04S4-H1	OptiMOS™ -T2	1.60	160	0.90	2.00 ... 4.00	105.00	Normal	TO263-7-3 (TO220-7 (SMD))
AUIRF7738L2	Gen 10.7	1.60	184	1.60	2.00 ... 4.00	129.00	Normal	DirectFET™2 L6
IPLU250N04S4-1R7	OptiMOS™ -T2	1.70	250	0.80	2.00 ... 4.00	76.00	Normal	HSOF-8-1 (H-PSOF)
IPB120N04S4L-02	OptiMOS™ -T2	1.70	120	0.95	1.20 ... 2.20	143.00	Logic	TO263-3-2 (TO220-3 (SMD))
AUIRFP4004	Gen 10.2	1.70	195	0.40	2.00 ... 4.00	220.00	Normal	TO-247
IPB120N04S4-02	OptiMOS™ -T2	1.80	120	0.95	2.00 ... 4.00	103.00	Normal	TO263-3-2 (TO220-3 (SMD))
AUIRFS8407	Gen 12.7	1.80	195	0.65	2.20 ... 3.90	150.00	Normal	TO-263-3 (D ² PAK 3-leg)
AUIRFSL8407	Gen 12.7	1.80	195	0.65	2.20 ... 3.90	150.00	Normal	TO-262
IPI120N04S4-01	OptiMOS™ -T2	1.90	120	0.80	2.00 ... 4.00	135.00	Normal	TO262-3
IPP120N04S4-01	OptiMOS™ -T2	1.90	120	0.80	2.00 ... 4.00	135.00	Normal	TO220-3
AUIRF7737L2	Gen 10.7	1.90	156	1.80	2.00 ... 4.00	89.00	Normal	DirectFET™2 L6
AUIRF8736M2	Gen 12.7	1.90	137	2.40	2.20 ... 3.90	136.00	Normal	DirectFET™2 M4
AUIRFR8405	Gen 12.7	1.98	100	0.92	2.20 ... 3.90	103.00	Normal	TO-252 (DPAK 3-leg)
AUIRFU8405	Gen 12.7	1.98	100	0.92	2.20 ... 3.90	103.00	Normal	IPAK
IPD100N04S4-02	OptiMOS™ -T2	2.00	100	1.00	2.00 ... 4.00	91.00	Normal	TO252-3 (DPAK)
IPD100N04S4L-02	OptiMOS™ -T2	1.90	100	1.00	1.20 ... 2.20	126.00	Logic	TO252-3 (DPAK)
AUIRFB8407	Gen 12.7	2.00	195	0.65	2.20 ... 3.90	150.00	Normal	TO-220
IPB90N04S4-02	OptiMOS™ -T2	2.10	90	1.00	2.00 ... 4.00	91.00	Normal	TO263-3-2 (TO220-3 (SMD))
IPI120N04S4-02	OptiMOS™ -T2	2.10	120	0.95	2.00 ... 4.00	103.00	Normal	TO262-3
AUIRFSL8405	Gen 12.7	2.30	120	0.92	2.20 ... 3.90	107.00	Normal	TO-262
IPD90N04S4-02	OptiMOS™ -T2	2.40	90	1.00	2.00 ... 4.00	91.00	Normal	TO252-3 (DPAK)
IPB100N04S4-H2	OptiMOS™ -T2	2.40	100	1.30	2.00 ... 4.00	70.00	Normal	TO263-3-2 (TO220-3 (SMD))
NEW! IPC100N04S5L-1R1	OptiMOS™ -5	1.10	100	1.00	2.20 ... 3.40	131.00	Logic	TDSON-8-23
NEW! IPC100N04S5-1R2	OptiMOS™ -5	1.20	100	1.00	2.20 ... 3.40	131.00	Normal	TDSON-8-23
NEW! IPC100N04S5L-1R5	OptiMOS™ -5	1.50	100	1.30	2.20 ... 3.40	83.00	Logic	TDSON-8-23
NEW! IPC100N04S5-1R7	OptiMOS™ -5	1.70	100	1.30	2.20 ... 3.40	83.00	Normal	TDSON-8-23
NEW! IPC100N04S5L-1R9	OptiMOS™ -5	1.90	100	1.50	1.20 ... 2.00	81.00	Logic	TDSON-8-23
NEW! IPC100N04S5-1R9	OptiMOS™ -5	1.90	100	1.50	1.20 ... 2.00	81.00	Normal	TDSON-8-23
NEW! IPC50N04S5L-5R5	OptiMOS™ -5	5.50	50	3.60	1.20 ... 2.00	23.00	Logic	TDSON-8-23
NEW! IPC50N04S5-5R8	OptiMOS™ -5	5.80	50	3.60	1.20 ... 2.00	23.00	Normal	TDSON-8-23
IPI90N04S4-02	OptiMOS™ -T2	2.50	90	1.00	2.00 ... 4.00	91.00	Normal	TO262-3
AUIRFB8405	Gen 12.7	2.50	120	0.92	2.20 ... 3.90	107.00	Normal	TO-220
IPI100N04S4-H2	OptiMOS™ -T2	2.70	100	1.30	2.00 ... 4.00	70.00	Normal	TO262-3
IPP100N04S4-H2	OptiMOS™ -T2	2.70	100	1.30	2.00 ... 4.00	70.00	Normal	TO220-3
IPZ40N04S5L-2R8	OptiMOS™ -5	2.80	40	2.10	1.20 ... 2.00	30.00	Logic	TDSON-8
AUIRF7736M2	Gen 10.7	3.00	108	2.40	2.00 ... 4.00	72.00	Normal	DirectFET™2 M4
AUIRL7736M2	Gen 10.7	3.00	112	2.40	1.00 ... 2.50	52.00	Logic	DirectFET™2 M4
IPZ40N04S5-3R1	OptiMOS™ -5	3.10	40	2.10	2.20 ... 3.40	21.00	Normal	TDSON-8
AUIRFR8403	Gen 12.7	3.10	100	1.52	2.20 ... 3.90	66.00	Normal	TO-252 (DPAK 3-leg)

Automotive N-Channel MOSFETs

40 V (Trench) (cont'd)



Product name	Technology	$R_{DS(on)}$ @ 10 V [mΩ]	I_D [A]	R_{thJC} (max) [K/W]	$V_{GS(th)}$ (min-max) [V]	Q_g (typ) [nC]	Normal/ logic level	Package
AUIRFU8403	Gen 12.7	3.10	100	1.52	2.20 ... 3.90	66.00	Normal	IPAK
AUIRL1404Z	Gen 10.2	3.10	160	0.75	1.40 ... 2.70	75.00	Logic	TO-220
AUIRL1404ZL	Gen 10.2	3.10	160	0.75	1.40 ... 2.70	75.00	Logic	TO-262
AUIRL1404ZS	Gen 10.2	3.10	160	0.75	1.40 ... 2.70	75.00	Logic	TO-263-3 (D ² PAK 3-leg)
IPD90N04S4-03	OptiMOS™ -T2	3.20	90	1.60	2.00 ... 4.00	51.00	Normal	TO252-3 (DPAK)
IPB80N04S4-03	OptiMOS™ -T2	3.30	80	1.60	2.00 ... 4.00	51.00	Normal	TO263-3-2 (TO220-3 (SMD))
AUIRFS8403	Gen 12.7	3.30	100	1.52	2.20 ... 3.90	62.00	Normal	TO-263-3 (D ² PAK 3-leg)
AUIRFSL8403	Gen 12.7	3.30	100	1.52	2.20 ... 3.90	62.00	Normal	TO-262
IPB120N04S4-04	OptiMOS™ -T2	3.60	120	1.90	2.00 ... 4.00	42.00	Normal	TO263-3-2 (TO220-3 (SMD))
IPI80N04S4-03	OptiMOS™ -T2	3.70	80	1.60	2.00 ... 4.00	51.00	Normal	TO262-3
IPP80N04S4-03	OptiMOS™ -T2	3.70	80	1.60	2.00 ... 4.00	51.00	Normal	TO220-3
AUIRF1404Z	Gen 10.2	3.70	160	0.75	2.00 ... 4.00	100.00	Normal	TO-220
AUIRF1404ZL	Gen 10.2	3.70	160	0.75	2.00 ... 4.00	100.00	Normal	TO-262
AUIRF1404ZS	Gen 10.2	3.70	160	0.75	2.00 ... 4.00	100.00	Normal	TO-263-3 (D ² PAK 3-leg)
IPD90N04S4L-04	OptiMOS™ -T2	3.80	90	2.10	1.20 ... 2.00	46.00	Logic	TO252-3 (DPAK)
IPB80N04S4L-04	OptiMOS™ -T2	4.00	80	2.10	1.20 ... 2.00	46.00	Logic	TO263-3-2 (TO220-3 (SMD))
IPD90N04S4-04	OptiMOS™ -T2	4.10	90	2.10	2.00 ... 4.00	33.00	Normal	TO252-3 (DPAK)
IPB80N04S4-04	OptiMOS™ -T2	4.20	80	2.10	2.00 ... 4.00	33.00	Normal	TO263-3-2 (TO220-3 (SMD))
AUIRFR8401	Gen 12.7	4.25	100	1.90	2.20 ... 3.90	42.00	Normal	TO-252 (DPAK 3-leg)
AUIRFU8401	Gen 12.7	4.25	100	1.90	2.20 ... 3.90	42.00	Normal	IPAK
IPI80N04S4L-04	OptiMOS™ -T2	4.30	80	2.10	1.20 ... 2.00	46.00	Logic	TO262-3
IPP80N04S4L-04	OptiMOS™ -T2	4.30	80	2.10	1.20 ... 2.00	46.00	Logic	TO220-3
IPI80N04S4-04	OptiMOS™ -T2	4.60	80	2.10	2.00 ... 4.00	33.00	Normal	TO262-3
IPP80N04S4-04	OptiMOS™ -T2	4.60	80	2.10	2.00 ... 4.00	33.00	Normal	TO220-3
IPZ40N04S5L-4R8	OptiMOS™ -5	4.80	40	3.50	1.20 ... 2.00	17.00	Logic	TS2SON-8
IPZ40N04S5-5R4	OptiMOS™ -5	5.40	40	3.50	2.20 ... 3.40	12.00	Normal	TS2SON-8
IPB70N04S4-06	OptiMOS™ -T2	6.20	70	2.60	2.00 ... 4.00	24.50	Normal	TO263-3-2 (TO220-3 (SMD))
IPI70N04S4-06	OptiMOS™ -T2	6.50	70	2.60	2.00 ... 4.00	24.50	Normal	TO262-3
IPP70N04S4-06	OptiMOS™ -T2	6.50	70	2.60	2.00 ... 4.00	24.50	Normal	TO220-3
AUIRL7732S2	Gen 10.7	6.60	58	3.50	1.00 ... 2.50	24.00	Logic	DirectFET™2 SC
AUIRF7732S2	Gen 10.7	6.95	55	3.70	2.00 ... 4.00	30.00	Normal	DirectFET™2 SC
IPD50N04S4L-08	OptiMOS™ -T2	7.30	50	3.30	1.20 ... 2.00	23.00	Logic	TO252-3 (DPAK)
IPZ40N04S5L-7R4	OptiMOS™ -5	7.40	40	4.40	1.20 ... 2.00	10.00	Logic	TS2SON-8
IPI45N04S4L-08	OptiMOS™ -T2	7.60	45	3.30	1.20 ... 2.00	23.00	Logic	TO262-3
IPP45N04S4L-08	OptiMOS™ -T2	7.60	45	3.30	1.20 ... 2.00	23.00	Logic	TO220-3
IPD50N04S4-08	OptiMOS™ -T2	7.90	50	3.30	2.00 ... 4.00	17.20	Normal	TO252-3 (DPAK)
IPZ40N04S5-8R4	OptiMOS™ -5	8.40	40	4.40	2.20 ... 3.40	6.90	Normal	TS2SON-8
IPD50N04S4-10	OptiMOS™ -T2	9.30	50	3.70	2.00 ... 4.00	14.00	Normal	TO252-3 (DPAK)
AUIRFN8459	Gen 12.7	2 x 5.90	50	3.00	2.20 ... 3.90	40.00	Normal	PQFN 5x6 dual
IPG20N04S4L-07A	OptiMOS™	2 x 7.20	20	2.30	1.20 ... 2.20	39.00	Logic	TDSON-8-10
IPG20N04S4-08A	OptiMOS™	2 x 7.50	20	2.30	2.00 ... 4.00	28.00	Normal	TDSON-8-10
IPG20N04S4L-08A	OptiMOS™	2 x 8.10	20	2.80	1.20 ... 2.20	30.00	Logic	TDSON-8-10
IPG20N04S4L-11A	OptiMOS™	2 x 11.60	20	3.70	1.20 ... 2.20	20.00	Logic	TDSON-8-10
IPG20N04S4-12A	OptiMOS™	2 x 12.20	20	3.70	2.00 ... 4.00	14.00	Normal	TDSON-8-10

55 V (Trench)



Product name	Technology	$R_{DS(on)}$ @ 10 V [mΩ]	I_D [A]	R_{thJC} (max) [K/W]	$V_{GS(th)}$ (min-max) [V]	Q_G (typ) [nC]	Normal/ logic level	Package
AUIRF3805L-7P	Gen 10.2	2.60	240	0.40	2.00 ... 4.00	130	Normal	TO-263CA 7 pin
AUIRF3805S-7P	Gen 10.2	2.60	240	0.40	2.00 ... 4.00	130	Normal	TO-263-7 (D ² PAK 7-leg)
AUIRF3805	Gen 10.2	3.30	160	0.50	2.00 ... 4.00	190	Normal	TO-220
AUIRF3805L	Gen 10.2	3.30	160	0.50	2.00 ... 4.00	190	Normal	TO-262
AUIRF1405ZL	Gen 10.2	4.90	150	0.65	2.00 ... 4.00	120	Normal	TO-262
AUIRF1405ZS	Gen 10.2	4.90	150	0.65	2.00 ... 4.00	120	Normal	TO-263-3 (D ² PAK 3-leg)
AUIRF1405ZS-7P	Gen 10.2	4.90	150	0.65	2.00 ... 4.00	120	Normal	TO-263-7 (D ² PAK 7-leg)
AUIRF3205Z	Gen 10.2	6.50	75	0.90	2.00 ... 4.00	76	Normal	TO-220
AUIRF1010Z	Gen 10.2	7.50	75	1.11	2.00 ... 4.00	63	Normal	TO-220
AUIRL3705Z	Gen 10.2	8.00	75	1.14	1.00 ... 3.00	40	Logic	TO-220
AUIRFR48Z	Gen 10.2	11.00	42	1.64	2.00 ... 4.00	40	Normal	TO-252 (DPAK 3-leg)
AUIRFZ48Z	Gen 10.2	11.00	61	1.64	2.00 ... 4.00	43	Normal	TO-220
AUIRLZ44Z	Gen 10.2	13.50	51	1.87	1.00 ... 3.00	24	Logic	TO-220
AUIRLZ44ZL	Gen 10.2	13.50	51	1.87	1.00 ... 3.00	24	Logic	TO-262
AUIRLZ44ZS	Gen 10.2	13.50	51	1.87	1.00 ... 3.00	24	Logic	TO-263-3 (D ² PAK 3-leg)
AUIRFZ44ZS	Gen 10.2	13.90	51	1.87	2.00 ... 4.00	29	Normal	TO-263-3 (D ² PAK 3-leg)
AUIRFZ44Z	Gen 10.2	13.90	51	1.87	2.00 ... 4.00	29	Normal	TO-220
AUIRFR2905Z	Gen 10.2	14.50	42	1.38	2.00 ... 4.00	29	Normal	TO-252 (DPAK 3-leg)
AUIRFR4105Z	Gen 10.2	24.50	30	3.12	2.00 ... 4.00	18	Normal	TO-252 (DPAK 3-leg)
AUIRLR024Z	Gen 10.2	58.00	16	4.28	1.00 ... 3.00	7	Logic	TO-252 (DPAK 3-leg)
AUIRLU024Z	Gen 10.2	58.00	16	4.28	1.00 ... 3.00	7	Logic	IPAK
AUIRL024Z	Gen 10.2	60.00	5	n/a	2.00 ... 4.00	7	Normal	SOT-223

60 V (Trench)



Product name	Technology	$R_{DS(on)}$ @ 10 V [mΩ]	I_D [A]	R_{thJC} (max) [K/W]	$V_{GS(th)}$ (min-max) [V]	Q_G (typ) [nC]	Normal/ logic level	Package
AUIRF7749L2	Gen 10.7	1.50	200	1.50	2.00 ... 4.00	200.00	Normal	DirectFET™2 L8
IPB180N06S4-H1	OptiMOS™ -T2	1.70	180	0.60	2.00 ... 4.00	208.00	Normal	TO263-7-3 (TO220-7 (SMD))
AUIRLS3036-7P	Gen 10.7	1.90	240	0.40	1.00 ... 2.50	110.00	Logic	TO-263-7 (D ² PAK 7-leg)
IPB120N06S4-H1	OptiMOS™ -T2	2.00	120	0.60	2.00 ... 4.00	208.00	Normal	TO263-3-2 (TO220-3 (SMD))
IPB120N06S4-02	OptiMOS™ -T2	2.40	120	0.80	2.00 ... 4.00	150.00	Normal	TO263-3-2 (TO220-3 (SMD))
IPP120N06S4-H1	OptiMOS™ -T2	2.40	120	0.60	2.00 ... 4.00	208.00	Normal	TO220-3
AUIRLS3036	Gen 10.7	2.40	195	0.40	1.00 ... 2.50	91.00	Logic	TO-263-3 (D ² PAK 3-leg)
IPB120N06S4-03	OptiMOS™ -T2	2.80	120	0.90	2.00 ... 4.00	125.00	Normal	TO263-3-2 (TO220-3 (SMD))
IPI120N06S4-02	OptiMOS™ -T2	2.80	120	0.80	2.00 ... 4.00	150.00	Normal	TO262-3
IPB90N06S4L-04	OptiMOS™ -T2	3.40	90	1.00	1.20 ... 2.00	133.00	Logic	TO263-3-2 (TO220-3 (SMD))
IPI90N06S4L-04	OptiMOS™ -T2	3.40	90	1.00	1.20 ... 2.00	133.00	Logic	TO262-3
IPD100N06S4-03	OptiMOS™ -T2	3.50	100	1.00	2.00 ... 4.00	99.00	Normal	TO252-3 (DPAK)
IPD90N06S4L-03	OptiMOS™ -T2	3.50	90	1.00	1.20 ... 2.00	133.00	Logic	TO252-3 (DPAK)
IPB90N06S4-04	OptiMOS™ -T2	3.70	90	1.00	2.00 ... 4.00	99.00	Normal	TO263-3-2 (TO220-3 (SMD))
IPD90N06S4-04	OptiMOS™ -T2	3.80	90	1.00	2.00 ... 4.00	99.00	Normal	TO252-3 (DPAK)
IPI90N06S4-04	OptiMOS™ -T2	4.00	90	1.00	2.00 ... 4.00	99.00	Normal	TO262-3
AUIRFS3306	Gen 10.7	4.20	120	0.65	2.00 ... 4.00	85.00	Normal	TO-263-3 (D ² PAK 3-leg)
IPD90N06S4L-05	OptiMOS™ -T2	4.60	90	1.40	1.20 ... 2.00	83.00	Logic	TO252-3 (DPAK)
IPB80N06S4L-05	OptiMOS™ -T2	4.80	80	1.40	1.20 ... 2.00	83.00	Logic	TO263-3-2 (TO220-3 (SMD))
IPD90N06S4-05	OptiMOS™ -T2	5.10	90	1.40	2.00 ... 4.00	62.00	Normal	TO252-3 (DPAK)
IPB80N06S4-05	OptiMOS™ -T2	5.40	80	1.40	2.00 ... 4.00	62.00	Normal	TO263-3-2 (TO220-3 (SMD))
IPB80N06S4-07	OptiMOS™ -T2	7.10	80	1.90	2.00 ... 4.00	43.00	Normal	TO263-3-2 (TO220-3 (SMD))

Automotive N-Channel MOSFETs

60 V (Trench) (cont'd)



Product name	Technology	$R_{DS(on)}$ @ 10 V [mΩ]	I_D [A]	R_{thJC} (max) [K/W]	$V_{GS(th)}$ (min-max) [V]	Q_G (typ) [nC]	Normal/ logic level	Package
IPI80N06S4-05	OptiMOS™ -T2	5.40	80	1.40	2.00 ... 4.00	62.00	Normal	TO262-3
IPD90N06S4L-06	OptiMOS™ -T2	6.30	90	1.90	1.20 ... 2.00	58.00	Logic	TO252-3 (DPAK)
IPB80N06S4L-07	OptiMOS™ -T2	6.40	80	1.90	1.20 ... 2.00	58.00	Logic	TO263-3-2 (TO220-3 (SMD))
IPI80N06S4L-07	OptiMOS™ -T2	6.40	80	1.90	1.20 ... 2.00	58.00	Logic	TO262-3
IPD90N06S4-07	OptiMOS™ -T2	6.90	90	1.90	2.00 ... 4.00	43.00	Normal	TO252-3 (DPAK)
AUIRF7648M2	Gen 10.7	7.00	68	2.40	3.00 ... 4.90	35.00	Normal	DirectFET™2 M4
IPI80N06S4-07	OptiMOS™ -T2	7.40	80	1.90	2.00 ... 4.00	43.00	Normal	TO262-3
IPD50N06S4L-08	OptiMOS™ -T2	7.80	50	2.10	1.20 ... 2.00	49.00	Logic	TO252-3 (DPAK)
IPB45N06S4L-08	OptiMOS™ -T2	7.90	45	2.10	1.20 ... 2.00	49.00	Logic	TO263-3-2 (TO220-3 (SMD))
IPI45N06S4L-08	OptiMOS™ -T2	8.20	45	2.10	1.20 ... 2.00	49.00	Logic	TO262-3
AUIRF1010EZS	Gen 10.2	8.50	75	1.11	2.00 ... 4.00	58.00	Normal	TO-263-3 (D ² PAK 3-leg)
IPD50N06S4-09	OptiMOS™ -T2	9.00	50	2.10	2.00 ... 4.00	36.00	Normal	TO252-3 (DPAK)
IPI45N06S4-09	OptiMOS™ -T2	9.40	45	2.10	2.00 ... 4.00	36.00	Normal	TO262-3
IPP45N06S4-09	OptiMOS™ -T2	9.40	45	2.10	2.00 ... 4.00	36.00	Normal	TO220-3
IPD50N06S4L-12	OptiMOS™ -T2	12.00	50	3.00	1.20 ... 2.00	30.00	Logic	TO252-3 (DPAK)
AUIRFZ44VZS	Gen 10.2	12.00	57	1.64	2.00 ... 4.00	43.00	Normal	TO-263-3 (D ² PAK 3-leg)
AUIRFR3806	Gen 10.7	15.80	43	2.12	2.00 ... 4.00	22.00	Normal	TO-252 (DPAK 3-leg)
AUIRFS3806	Gen 10.7	15.80	43	2.12	2.00 ... 4.00	22.00	Normal	TO-263-3
IPD30N06S4L-23	OptiMOS™ -T2	23.00	30	4.20	1.20 ... 2.00	16.10	Logic	TO252-3 (DPAK)
IPD25N06S4L-30	OptiMOS™ -T2	30.00	25	5.10	1.20 ... 2.00	12.50	Logic	TO252-3 (DPAK)
AUIRF7640S2	Gen 10.7	36.00	21	5.00	3.00 ... 5.00	7.00	Normal	DirectFET™2 SB
IPG20N06S4L-11	OptiMOS™ -T2	2 x 11.10	20	2.30	1.20 ... 2.20	41.00	Logic	TDSON-8-4 dual
IPG20N06S4L-11A	OptiMOS™ -T2	2 x 11.10	20	2.30	1.20 ... 2.20	41.00	Logic	TDSON-8-10
IPG20N06S4L-14	OptiMOS™ -T2	2 x 13.70	20	3.00	1.20 ... 2.20	30.00	Logic	TDSON-8-4 dual
IPG20N06S4L-14A	OptiMOS™ -T2	2 x 13.70	20	3.00	1.20 ... 2.20	30.00	Logic	TDSON-8-10
IPG20N06S4-15	OptiMOS™ -T2	2 x 15.50	20	3.00	2.00 ... 4.00	22.00	Normal	TDSON-8-4 dual
IPG20N06S4-15A	OptiMOS™ -T2	2 x 15.50	20	3.00	2.00 ... 4.00	22.00	Normal	TDSON-8-10
IPG20N06S4L-26	OptiMOS™ -T2	2 x 26.00	20	4.50	1.20 ... 2.20	20.00	Logic	TDSON-8-4 dual
IPG20N06S4L-26A	OptiMOS™ -T2	2 x 26.00	20	4.50	1.20 ... 2.20	20.00	Logic	TDSON-8-10

75 V (Trench)



Product name	Technology	$R_{DS(on)}$ @ 10 V [mΩ]	I_D [A]	R_{thJC} (max) [K/W]	$V_{GS(th)}$ (min-max) [V]	Q_G (typ) [nC]	Normal/ logic level	Package
AUIRF7759L2	Gen 10.7	2.30	160	1.20	2.00 ... 4.00	200	Normal	DirectFET™2 L8
AUIRFS3107	Gen 10.7	3.00	195	0.40	2.00 ... 4.00	160	Normal	TO-263-3 (D ² PAK 3-leg)
IPB80N07S4-05	OptiMOS™ -T2	5.20	80	1.00	2.00 ... 4.00	69	Normal	TO263-3-2 (TO220-3 (SMD))
IPI80N07S4-05	OptiMOS™ -T2	5.20	80	1.00	2.00 ... 4.00	69	Normal	TO262-3
IPP80N08S4-06	OptiMOS™ -T2	5.50	80	1.00	2.00 ... 4.00	70	Normal	TO220-3
AUIRF2907Z	Gen 10.2	4.50	75	0.50	2.00 ... 4.00	180	Normal	TO-220
AUIRFB3207	Gen 10.2	4.50	75	0.50	2.00 ... 4.00	180	Normal	TO-220
AUIRFP2907Z	Gen 10.2	4.50	75	0.50	2.00 ... 4.00	180	Normal	TO-247
AUIRFN7107	Gen 10.7	8.50	76	1.20	2.00 ... 4.00	52	Normal	PQFN 5x6 mm
AUIRFR2607Z	Gen 10.2	22.00	42	1.38	2.00 ... 4.00	34	Normal	TO-252 (DPAK 3-leg)

80 V (Trench)



NEW!

NEW!

Product name	Technology	$R_{DS(on)}$ @ 10 V [mΩ]	I_b [A]	$R_{th,jc}$ (max) [K/W]	$V_{GS(th)}$ (min-max) [V]	Q_G (typ) [nC]	Normal/ logic level	Package
IAUT300N08S5N012	OptiMOS™ -5	1.20	300	0.40	2.20 ... 3.80	178	Normal	HSOF-8-1 (H-PSOF)
IPB180N08S4-02	OptiMOS™ -T2	2.20	180	0.54	2.00 ... 4.00	167	Normal	TO263-7-3 (TO220-7 (SMD))
IPB120N08S4-03	OptiMOS™ -T2	2.50	120	0.54	2.00 ... 4.00	167	Normal	TO263-3-2 (TO220-3 (SMD))
IPI120N08S4-03	OptiMOS™ -T2	2.50	120	0.54	2.00 ... 4.00	167	Normal	TO262-3
IPP120N08S4-03	OptiMOS™ -T2	2.50	120	0.54	2.00 ... 4.00	167	Normal	TO220-3
IAUT165N08S5N029	OptiMOS™ -5	2.90	165	0.90	2.20 ... 3.80	70	Normal	HSOF-8-1 (H-PSOF)
IPB160N08S4-03	OptiMOS™ -T2	3.20	160	0.72	2.00 ... 4.00	112	Normal	TO263-7-3 (TO220-7 (SMD))
IPB120N08S4-04	OptiMOS™ -T2	4.10	120	0.84	2.00 ... 4.00	95	Normal	TO263-3-2 (TO220-3 (SMD))
IPI120N08S4-04	OptiMOS™ -T2	4.10	120	0.84	2.00 ... 4.00	95	Normal	TO262-3
IPP120N08S4-04	OptiMOS™ -T2	4.10	120	0.84	2.00 ... 4.00	95	Normal	TO220-3
IPB140N08S4-04	OptiMOS™ -T2	4.20	140	0.90	2.00 ... 4.00	80	Normal	TO263-7-3 (TO220-7 (SMD))
IPP80N07S4-05	OptiMOS™ -T2	5.20	80	1.00	2.00 ... 4.00	69	Normal	TO220-3
IPD90N08S4-05	OptiMOS™ -T2	5.30	90	1.00	2.00 ... 4.00	68	Normal	TO252-3 (DPAK)
IPB80N08S4-06	OptiMOS™ -T2	5.50	80	1.00	2.00 ... 4.00	70	Normal	TO263-3-2 (TO220-3 (SMD))
IPI80N08S4-06	OptiMOS™ -T2	5.50	80	1.00	2.00 ... 4.00	70	Normal	TO262-3
IPD50N08S4-13	OptiMOS™ -T2	13.20	50	2.10	2.00 ... 4.00	30	Normal	TO252-3 (DPAK)

100 V (Trench)



Product name	Technology	$R_{DS(on)}$ @ 10 V [mΩ]	I_b [A]	$R_{th,jc}$ (max) [K/W]	$V_{GS(th)}$ (min-max) [V]	Q_G (typ) [nC]	Normal/ logic level	Package
IPB180N10S4-02	OptiMOS™ -T2	2.50	180	0.50	2.00 ... 3.50	156.00	Normal	TO263-7-3 (TO220-7 (SMD))
IPB180N10S4-03	OptiMOS™ -T2	3.30	180	0.60	2.00 ... 3.50	108.00	Normal	TO263-7-3 (TO220-7 (SMD))
IPB120N10S4-03	OptiMOS™ -T2	3.50	120	0.60	2.00 ... 3.50	108.00	Normal	TO263-3-2 (TO220-3 (SMD))
IPI120N10S4-03	OptiMOS™ -T2	3.50	120	0.60	2.00 ... 3.50	108.00	Normal	TO262-3
IPP120N10S4-03	OptiMOS™ -T2	3.50	120	0.60	2.00 ... 3.50	108.00	Normal	TO220-3
AUIRF7769L2	Gen 10.7	3.50	124	1.20	2.00 ... 4.00	200.00	Normal	DirectFET™2 L8
AUIRLS4030-7P	Gen 10.7	3.90	190	0.40	1.00 ... 2.50	93.00	Logic	TO-263-7 (D ² PAK 7-leg)
AUIRLS4030	Gen 10.7	4.30	180	0.40	1.00 ... 2.50	87.00	Logic	TO-263-3 (D ² PAK 3-leg)
AUIRF7669L2	Gen 10.7	4.40	114	1.20	3.00 ... 5.00	81.00	Normal	DirectFET™2 L8
AUIRFP4110	Gen 10.7	4.50	120	0.40	2.00 ... 4.00	150.00	Normal	TO-247
IPB120N10S4-05	OptiMOS™ -T2	5.00	120	0.80	2.00 ... 3.50	70.00	Normal	TO263-3-2 (TO220-3 (SMD))
IPI120N10S4-05	OptiMOS™ -T2	5.00	120	0.80	2.00 ... 3.50	70.00	Normal	TO262-3
IPP120N10S4-05	OptiMOS™ -T2	5.00	120	0.80	2.00 ... 3.50	70.00	Normal	TO220-3
AUIRFS4310Z	Gen 10.7	6.00	120	0.60	2.00 ... 4.00	120.00	Normal	TO-263-3 (D ² PAK 3-leg)
IPD90N10S4L-06	OptiMOS™ -T2	6.60	90	1.10	1.10 ... 2.10	75.00	Logic	TO252-3 (DPAK)
IPD90N10S4-06	OptiMOS™ -T2	6.70	90	1.10	2.00 ... 3.50	52.00	Normal	TO252-3 (DPAK)
AUIRFS4310	Gen 10.2	7.00	75	0.50	2.00 ... 4.00	170.00	Normal	TO-263-3 (D ² PAK 3-leg)
AUIRFB4410	Gen 10.2	10.00	75	0.61	2.00 ... 4.00	120.00	Normal	TO-220
AUIRL766M2	Gen 10.7	10.00	51	2.40	1.00 ... 2.50	44.00	Logic	DirectFET™2 M4
IPB70N10S3-12	OptiMOS™ -T	11.30	70	1.20	2.00 ... 4.00	51.00	Normal	TO263-3-2 (TO220-3 (SMD))
IPI70N10S3-12	OptiMOS™ -T	11.60	70	1.20	2.00 ... 4.00	51.00	Normal	TO262-3
IPB70N10S3L-12	OptiMOS™ -T	11.80	70	1.20	1.20 ... 2.40	60.00	Logic	TO263-3-2 (TO220-3 (SMD))
IPD60N10S4L-12	OptiMOS™ -T2	12.00	60	1.60	1.10 ... 2.10	38.00	Logic	TO252-3 (DPAK)
IPI70N10S3L-12	OptiMOS™ -T	12.10	70	1.20	1.20 ... 2.40	60.00	Logic	TO262-3
IPP70N10S3L-12	OptiMOS™ -T	12.10	70	1.20	1.20 ... 2.40	60.00	Logic	TO220-3
IPD60N10S4-12	OptiMOS™ -T2	12.20	60	1.60	2.00 ... 3.50	26.00	Normal	TO252-3 (DPAK)
AUIRFB4610	Gen 10.2	14.00	73	0.77	2.00 ... 4.00	90.00	Normal	TO-220
AUIRFN7110	Gen 10.7	14.50	58	1.20	2.00 ... 4.00	49.00	Normal	PQFN 5x6 mm

Automotive N-Channel MOSFETs

100 V (Trench) (cont'd)



Product name	Technology	$R_{DS(on)}$ @ 10 V [mΩ]	I_D [A]	$R_{th,jc}$ (max) [K/W]	$V_{GS(th)}$ (min-max) [V]	Q_G (typ) [nC]	Normal/ logic level	Package
IPB50N10S3L-16	OptiMOS™ -T	15.40	70	1.50	1.20 ... 2.40	49.00	Logic	TO263-3-2 (TO220-3 (SMD))
IPI50N10S3L-16	OptiMOS™ -T	15.70	50	1.50	1.20 ... 2.40	49.00	Logic	TO262-3
IPP50N10S3L-16	OptiMOS™ -T	15.70	50	1.50	1.20 ... 2.40	49.00	Logic	TO220-3
AUIRF3710Z	Gen 10.2	18.00	59	0.92	2.00 ... 4.00	82.00	Normal	TO-220
AUIRF3710ZS	Gen 10.2	18.00	59	0.92	2.00 ... 4.00	82.00	Normal	TO-263-3 (D ² PAK 3-leg)
IPD35N10S3L-26	OptiMOS™ -T	24.00	35	2.10	1.20 ... 2.40	39.00	Logic	TO252-3 (DPAK)
AUIRF540ZS	Gen 10.2	26.50	36	1.64	2.00 ... 4.00	42.00	Normal	TO-263-3 (D ² PAK 3-leg)
AUIRFR540Z	Gen 10.2	26.50	36	1.64	2.00 ... 4.00	42.00	Normal	TO-252 (DPAK 3-leg)
AUIRF540Z	Gen 10.2	26.50	36	1.64	2.00 ... 4.00	43.00	Normal	TO-220
IPD30N10S3L-34	OptiMOS™ -T	31.00	30	2.60	1.20 ... 2.40	24.00	Logic	TO252-3 (DPAK)
AUIRF7647S2	Gen 10.7	31.00	24	3.70	3.00 ... 5.00	14.00	Normal	DirectFET™2 SC
AUIRF7665S2	Gen 10.7	62.00	14	5.00	3.00 ... 5.00	8.00	Normal	DirectFET™2 SB
AUIRFR120Z	Gen 10.2	190.00	9	4.28	2.00 ... 4.00	7.00	Normal	TO-252 (DPAK 3-leg)
AUIRFU120Z	Gen 10.2	190.00	9	4.28	2.00 ... 4.00	7.00	Normal	IPAK
IPG20N10S4L-22A	OptiMOS™ -T2	2 x 22.00	20	2.50	1.10 ... 2.10	21.00	Logic	TDSON-8-10
IPG20N10S4L-35A	OptiMOS™ -T2	2 x 35.00	20	3.50	1.10 ... 2.10	13.40	Logic	TDSON-8-10
IPG20N10S4-36A	OptiMOS™ -T2	2 x 36.00	20	3.50	2.00 ... 3.50	9.40	Normal	TDSON-8-10
IPG16N10S4-61A	OptiMOS™ -T2	2 x 61.00	16	5.20	2.00 ... 3.50	5.40	Normal	TDSON-8-10
IPG16N10S4L-61A	OptiMOS™ -T2	2 x 61.00	16	5.20	1.10 ... 2.10	8.50	Logic	TDSON-8-10

120 V (Trench)



NEW!
NEW!
NEW!
NEW!
NEW!
NEW!
NEW!
NEW!
NEW!
NEW!
NEW!
NEW!
NEW!
NEW!
NEW!
NEW!
NEW!
NEW!
NEW!
NEW!

Product name	Technology	$R_{DS(on)}$ @ 10 V [mΩ]	I_D [A]	$R_{th,jc}$ (max) [K/W]	$V_{GS(th)}$ (min-max) [V]	Q_G (typ) [nC]	Normal/ logic level	Package
IPI100N12S3-05	OptiMOS™ -T2	4.80	100	0.50	2.00 ... 4.00	139	Normal	TO262-3
IPP100N12S3-05	OptiMOS™ -T2	4.80	100	0.50	2.00 ... 4.00	139	Normal	TO220-3
IPB100N12S3-05	OptiMOS™ -T2	4.80	100	0.50	2.00 ... 4.00	139	Normal	TO263-3
IPD70N12S3-11	OptiMOS™ -T2	11.10	70	1.20	2.00 ... 4.00	51	Normal	TO252-3 (DPAK)
IPI70N12S3-11	OptiMOS™ -T2	11.30	70	1.20	2.00 ... 4.00	51	Normal	TO262-3
IPP70N12S3-11	OptiMOS™ -T2	11.30	70	1.20	2.00 ... 4.00	51	Normal	TO220-3
IPB70N12S3-11	OptiMOS™ -T2	11.30	70	1.20	2.00 ... 4.00	51	Normal	TO263-3
IPD70N12S3L-12	OptiMOS™ -T2	11.50	70	1.20	1.20 ... 2.40	59	Logic	TO252-3 (DPAK)
IPI70N12S3L-12	OptiMOS™ -T2	11.80	70	1.20	1.20 ... 2.40	59	Logic	TO262-3
IPP70N12S3L-12	OptiMOS™ -T2	11.80	70	1.20	1.20 ... 2.40	59	Logic	TO220-3
IPB70N12S3L-12	OptiMOS™ -T2	11.80	70	1.20	1.20 ... 2.40	59	Logic	TO263-3
IPI50N12S3L-15	OptiMOS™ -T2	15.40	50	1.50	1.20 ... 2.40	44	Logic	TO262-3
IPP50N12S3L-15	OptiMOS™ -T2	15.40	50	1.50	1.20 ... 2.40	44	Logic	TO220-3
IPB50N12S3L-15	OptiMOS™ -T2	15.40	50	1.50	1.20 ... 2.40	44	Logic	TO263-3
IPD50N12S3L-15	OptiMOS™ -T2	15.00	50	1.50	1.20 ... 2.40	44	Logic	TO252-3 (DPAK)
IPD35N12S3L-24	OptiMOS™ -T2	24.00	35	2.10	1.20 ... 2.40	30	Logic	TO252-3 (DPAK)
IPB35N12S3L-26	OptiMOS™ -T2	26.30	35	2.10	1.20 ... 2.40	30	Logic	TO263-3
IPD30N12S3L-31	OptiMOS™ -T2	31.00	30	2.60	1.20 ... 2.40	24	Logic	TO252-3 (DPAK)



150 V (Trench)

Product name	Technology	$R_{DS(on)}$ @ 10 V [mΩ]	I_D [A]	R_{thJC} (max) [K/W]	$V_{GS(th)}$ (min-max) [V]	Q_G (typ) [nC]	Normal/ logic level	Package
AUIRFP4568	Gen 10.7	5.90	171	0.29	3.00 ... 5.00	151	Normal	TO-247
AUIRFS4115-7P	Gen 10.7	11.80	105	0.40	3.00 ... 5.00	73	Normal	TO-263-7 (D ² PAK 7-leg)
AUIRFS4115	Gen 10.7	12.10	99	0.40	3.00 ... 5.00	77	Normal	TO-263-3 (D ² PAK 3-leg)
AUIRFR4615	Gen 10.7	42.00	33	1.05	3.00 ... 5.00	26	Normal	TO-252 (DPAK 3-leg)
AUIRF7675M2	Gen 10.7	56.00	18	3.30	3.00 ... 5.00	21	Normal	DirectFET™2 M2



200 V (Trench)

Product name	Technology	$R_{DS(on)}$ @ 10 V [mΩ]	I_D [A]	R_{thJC} (max) [K/W]	$V_{GS(th)}$ (min-max) [V]	Q_G (typ) [nC]	Normal/ logic level	Package
AUIRFR4620	Gen 10.7	78	24	1.05	3.00 ... 5.00	25	Normal	TO-252 (DPAK 3-leg)



250 V (Trench)

Product name	Technology	$R_{DS(on)}$ @ 10 V [mΩ]	I_D [A]	R_{thJC} (max) [K/W]	$V_{GS(th)}$ (min-max) [V]	Q_G (typ) [nC]	Normal/ logic level	Package
IPB64N25S3-20	OptiMOS™ T	20	64.00	0.50	2.00 ... 4.00	67	Normal	TO263-3-2 (TO220-3 (SMD))
AUIRF7799L2	Gen 10.7	32	35.00	1.20	3.00 ... 5.00	110	Normal	DirectFET™2 L8
IPB17N25S3-100	OptiMOS™ T	100	17.00	1.40	2.00 ... 4.00	14	Normal	TO263-3-2 (TO220-3 (SMD))
IPP17N25S3-100	OptiMOS™ T	100	17.00	1.40	2.00 ... 4.00	14	Normal	TO220-3
AUIRFR4292	Gen 10.7	345	9.30	1.50	3.00 ... 5.00	13	Normal	TO-252 (DPAK 3-leg)
IPD5N25S3-430	OptiMOS™ -T	430	5.00	3.70	2.00 ... 4.00	5	Normal	TO252-3 (DPAK)



300 V (Trench)

Product name	Technology	$R_{DS(on)}$ @ 10 V [mΩ]	I_D [A]	R_{thJC} (max) [K/W]	$V_{GS(th)}$ (min-max) [V]	Q_G (typ) [nC]	Normal/ logic level	Package
AUIRFP4409	Gen 10.7	69	38	0.44	3.00 ... 5.00	83	Normal	TO-247
AUIRFS6535	Gen 10.7	185	19	0.71	3.00 ... 5.00	38	Normal	TO-263-3 (D ² PAK 3-leg)
AUIRFS6535	Gen 10.7	185	19	0.71	3.00 ... 5.00	38	Normal	TO-262

Automotive N-Channel MOSFETs

30 V (Planar)



Product name	Technology	$R_{DS(on)}$ @ 10 V [mΩ]	I_D [A]	R_{thJC} (max) [K/W]	$V_{GS(th)}$ (min-max) [V]	Q_G (typ) [nC]	Normal/ logic level	Package
IPD50N03S2L-06	OptiMOS™	6.40	50.00	1.10	1.20 ... 2.00	50	Logic	TO252-3 (DPAK)
AUIRL2203N	Gen 7	7.00	75.00	0.85	1.00 ... 3.00	60	Logic	TO-220
IPD50N03S2-07	OptiMOS™	7.30	50.00	1.10	2.10 ... 4.00	52	Normal	TO252-3 (DPAK)
IPD30N03S2L-10	OptiMOS™	10.00	30.00	1.50	1.20 ... 2.00	31	Logic	TO252-3 (DPAK)
AUIRF7805Q	Gen 5	11.00	13.00	20.00	1.00 ... 3.00	11	Logic	SO-8 (DSO-8)
IPD30N03S2L-20	OptiMOS™	20.00	30.00	2.50	1.20 ... 2.00	14	Logic	TO252-3 (DPAK)
AUIRF7313Q	Gen 5	2 x 29.00	7.00	20.00	1.00 ... 3.00	22	Logic	SO-8 (DSO-8)
AUIRF7303Q	Gen 5	2 x 50.00	4.90	20.00	1.00 ... 3.00	14	Logic	SO-8 (DSO-8)

40 V (Planar)



Product name	Technology	$R_{DS(on)}$ @ 10 V [mΩ]	I_D [A]	R_{thJC} (max) [K/W]	$V_{GS(th)}$ (min-max) [V]	Q_G (typ) [nC]	Normal/ logic level	Package
IPB160N04S2L-03	OptiMOS™	2.70	160	0.50	1.20 ... 2.00	230	Logic	TO263-7-3 (TO220-7 (SMD))
IPB160N04S2-03	OptiMOS™	2.90	160	0.50	2.10 ... 4.00	123	Normal	TO263-7-3 (TO220-7 (SMD))
AUIRL1404S	Gen 7	4.00	75	0.75	1.00 ... 3.00	93	Logic	TO-263-3 (D ² PAK 3-leg)
IPB100N04S2-04	OptiMOS™	3.30	100	0.50	2.10 ... 4.00	172	Normal	TO263-3-2 (TO220-3 (SMD))
IPB80N04S2-04	OptiMOS™	3.40	80	0.50	2.10 ... 4.00	127	Normal	TO263-3-2 (TO220-3 (SMD))
IPB80N04S2-H4	OptiMOS™	3.70	80	0.50	1.20 ... 2.00	103	Normal	TO263-3-2 (TO220-3 (SMD))
IPI80N04S2-04	OptiMOS™	3.70	80	0.50	2.10 ... 4.00	170	Normal	TO262-3
IPI80N04S2-H4	OptiMOS™	4.00	80	0.50	2.10 ... 4.00	148	Normal	TO262-3
AUIRF1404S	Gen 7	4.00	75	0.75	2.00 ... 4.00	131	Normal	TO-263-3 (D ² PAK 3-leg)
AUIRF1404	Gen 7	4.00	75	0.75	2.00 ... 4.00	131	Normal	TO-220
AUIRF3504	Gen 7	9.20	87	1.09	2.00 ... 4.00	48	Normal	TO-252 (DPAK 3-leg)
AUIRF3504	Gen 7	9.20	87	1.09	2.00 ... 4.00	48	Normal	TO-220
AUIRF7484Q	Gen 7	10.00	14	20.00	1.00 ... 2.00	69	Logic	SO-8 (DSO-8)

50 V (Planar)



Product name	Technology	$R_{DS(on)}$ @ 10 V [mΩ]	I_D [A]	R_{thJC} (max) [K/W]	$V_{GS(th)}$ (min-max) [V]	Q_G (typ) [nC]	Normal/ logic level	Package
AUIRF7103Q	Gen 5	2 x 130	3	20.00	1.00 ... 3.00	10	Logic	SO-8 (DSO-8)

55 V (Planar)



Product name	Technology	$R_{DS(on)}$ @ 10 V [mΩ]	I_D [A]	R_{thJC} (max) [K/W]	$V_{GS(th)}$ (min-max) [V]	Q_G (typ) [nC]	Normal/ logic level	Package
IPB100N06S2L-05	OptiMOS™	4.40	100	0.50	1.20 ... 2.00	170.00	Logic	TO263-3-2 (TO220-3 (SMD))
IPB100N06S2-05	OptiMOS™	4.70	100	0.50	2.10 ... 4.00	130.00	Normal	TO263-3-2 (TO220-3 (SMD))
IPB80N06S2L-H5	OptiMOS™	4.70	80	0.50	1.20 ... 2.00	145.00	Logic	TO263-3-2 (TO220-3 (SMD))
IPP100N06S2L-05	OptiMOS™	4.70	100	0.50	1.20 ... 2.00	170.00	Logic	TO220-3
AUIRF2805	Gen 7	4.70	75	0.45	2.00 ... 4.00	150.00	Normal	TO-220
IPB80N06S2-05	OptiMOS™	4.80	80	0.50	2.10 ... 4.00	130.00	Normal	TO263-3-2 (TO220-3 (SMD))
IPI80N06S2L-05	OptiMOS™	4.80	80	0.50	1.20 ... 2.00	170.00	Logic	TO262-3
IPP80N06S2L-H5	OptiMOS™	5.00	80	0.50	1.20 ... 2.00	145.00	Logic	TO220-3
AUIRFBA1405	Gen 5	5.00	174	0.45	2.00 ... 4.00	170.00	Normal	TO-220
IPB80N06S2-H5	OptiMOS™	5.20	80	0.50	2.10 ... 4.00	116.00	Normal	TO263-3-2 (TO220-3 (SMD))
AUIRF1405	Gen 7	5.30	75	0.45	2.00 ... 4.00	170.00	Normal	TO-220

55 V (Planar) (cont'd)



Product name	Technology	$R_{DS(on)}$ @ 10 V [mΩ]	I_D [A]	R_{thJC} (max) [K/W]	$V_{GS(th)}$ (min-max) [V]	Q_G (typ) [nC]	Normal/ logic level	Package
AUIRFP1405	Gen 7	5.30	95	0.49	2.00 ... 4.00	120.00	Normal	TO-247
IPP80N06S2-H5	OptiMOS™	5.50	80	0.50	2.10 ... 4.00	116.00	Normal	TO220-3
IPB80N06S2L-06	OptiMOS™	6.00	80	0.60	1.20 ... 2.00	114.00	Logic	TO263-3-2 (TO220-3 (SMD))
IPB80N06S2-07	OptiMOS™	6.30	80	0.60	2.10 ... 4.00	86.00	Normal	TO263-3-2 (TO220-3 (SMD))
IPI80N06S2-07	OptiMOS™	6.60	80	0.60	2.10 ... 4.00	86.00	Normal	TO262-3
IPP80N06S2-07	OptiMOS™	6.60	80	0.60	2.10 ... 4.00	86.00	Normal	TO220-3
IPB80N06S2L-07	OptiMOS™	6.70	80	0.70	1.20 ... 2.00	95.00	Logic	TO263-3-2 (TO220-3 (SMD))
IPP80N06S2L-07	OptiMOS™	7.00	80	0.70	1.20 ... 2.00	95.00	Logic	TO220-3
IPB80N06S2-08	OptiMOS™	7.70	80	0.70	2.10 ... 4.00	72.00	Normal	TO263-3-2 (TO220-3 (SMD))
IPI80N06S2-08	OptiMOS™	8.00	80	0.70	2.10 ... 4.00	72.00	Normal	TO262-3
AUIRF3205	Gen 5	8.00	75	0.75	2.00 ... 4.00	97.00	Normal	TO-220
AUIRF3305	Gen 5	8.00	140	0.45	2.00 ... 4.00	100.00	Normal	TO-220
AUIRFP064N	Gen 5	8.00	110	0.75	2.00 ... 4.00	113.00	Normal	TO-247
IPB80N06S2L-09	OptiMOS™	8.20	80	0.80	1.20 ... 2.00	82.00	Logic	TO263-3-2 (TO220-3 (SMD))
IPP80N06S2L-09	OptiMOS™	8.50	80	0.80	1.20 ... 2.00	82.00	Logic	TO220-3
IPB80N06S2-09	OptiMOS™	8.80	80	0.80	2.10 ... 4.00	60.00	Normal	TO263-3-2 (TO220-3 (SMD))
IPP80N06S2-09	OptiMOS™	9.10	80	0.80	2.10 ... 4.00	60.00	Normal	TO220-3
IPP80N06S2L-09	OptiMOS™	11.00	80	0.95	1.20 ... 2.00	62.00	Logic	TO220-3
IPB77N06S2-12	OptiMOS™	11.70	77	0.95	2.10 ... 4.00	45.00	Normal	TO263-3-2 (TO220-3 (SMD))
IPP77N06S2-12	OptiMOS™	12.00	77	0.95	2.10 ... 4.00	45.00	Normal	TO220-3
IPD50N06S2L-13	OptiMOS™	12.70	50	1.10	1.20 ... 2.00	52.00	Logic	TO252-3 (DPAK)
IPD30N06S2L-13	OptiMOS™	13.00	30	1.10	1.20 ... 2.00	52.00	Logic	TO252-3 (DPAK)
AUIRFZ48N	Gen 7	14.00	64	0.95	2.00 ... 4.00	54.00	Normal	TO-220
IPD50N06S2-14	OptiMOS™	14.40	50	1.10	2.10 ... 4.00	39.00	Normal	TO252-3 (DPAK)
IPD30N06S2-15	OptiMOS™	14.70	30	1.10	1.20 ... 2.00	39.00	Normal	TO252-3 (DPAK)
AUIRFZ46NL	Gen 7	16.50	39	1.40	2.00 ... 4.00	48.00	Normal	TO-262
AUIRFZ44N	Gen 7	17.50	49	1.50	2.00 ... 4.00	42.00	Normal	TO-220
IPD30N06S2L-23	OptiMOS™	23.00	30	1.50	1.20 ... 2.00	33.00	Logic	TO252-3 (DPAK)
IPD30N06S2-23	OptiMOS™	23.00	30	1.50	2.10 ... 4.00	25.00	Normal	TO252-3 (DPAK)
AUIRLR2905	Gen 5	27.00	42	1.40	1.00 ... 2.00	36.00	Logic	TO-252 (DPAK 3-leg)
BSP603S2L	OptiMOS™	33.00	5.2	20.00	1.20 ... 2.00	31.00	Logic	SOT223
IPD26N06S2L-35	OptiMOS™	35.00	30	2.20	1.20 ... 2.00	10.00	Logic	TO252-3 (DPAK)
IPD25N06S2-40	OptiMOS™	40.00	29	2.20	2.10 ... 4.00	14.00	Normal	TO252-3 (DPAK)
AUIRFZ34N	Gen 5	40.00	21	4.10	2.00 ... 4.00	23.00	Normal	TO-220 FullPak
AUIRFZ34N	Gen 5	40.00	29	2.20	2.00 ... 4.00	23.00	Normal	TO-220
AUIRL2705	Gen 5	40.00	5	120.00	1.00 ... 3.00	32.00	Logic	SOT-223
AUIRLZ24NS	Gen 5	60.00	18	3.30	1.00 ... 2.00	7.00	Logic	TO-263-3 (D ² PAK 3-leg)
IPD15N06S2L-64	OptiMOS™	64.00	19	3.20	1.20 ... 2.00	11.00	Logic	TO252-3 (DPAK)
AUIRLL024N	Gen 5	65.00	4	120.00	1.00 ... 2.00	7.00	Logic	SOT-223
AUIRLR024N	Gen 5	65.00	17	3.30	1.00 ... 2.00	10.00	Logic	TO-252 (DPAK 3-leg)
AUIRFZ24NS	Gen 5	70.00	17	3.30	2.00 ... 4.00	13.00	Normal	TO-263-3 (D ² PAK 3-leg)
AUIRFL024N	Gen 5	75.00	3	120.00	2.00 ... 4.00	12.00	Normal	SOT-223
IPD14N06S2-80	OptiMOS™	80.00	17	3.20	2.10 ... 4.00	8.00	Normal	TO252-3 (DPAK)
AUIRLL014N	Gen 5	140.00	3	120.00	1.00 ... 2.00	10.00	Logic	SOT-223
AUIRLR014N	Gen 5	140.00	10	5.30	1.00 ... 3.00	5.00	Logic	TO-252 (DPAK 3-leg)
AUIRFL014N	Gen 5	160.00	2	120.00	2.00 ... 4.00	7.00	Normal	SOT-223
IPG20N06S2L-35	OptiMOS™	2 x 35.00	20	2.30	1.20 ... 2.20	18.00	Logic	TDSON-8-4 dual
IPG20N06S2L-35A	OptiMOS™	2 x 35.00	20	2.30	1.20 ... 2.20	18.00	Logic	Dual TDSON-8
AUIRF7341Q	Gen 5	2 x 50.00	5.1	20.00	1.00 ... 3.00	29.00	Logic	SO-8 (DSO-8)
IPG20N06S2L-50	OptiMOS™	2 x 50.00	20	2.90	1.20 ... 2.20	12.40	Logic	TDSON-8-4 dual
IPG20N06S2L-50A	OptiMOS™	2 x 50.00	20	2.90	1.20 ... 2.20	12.40	Logic	TDSON-8-10
IPG20N06S2L-65	OptiMOS™	2 x 65.00	20	3.50	1.20 ... 2.20	10.00	Logic	TDSON-8-4 dual
IPG20N06S2L-65A	OptiMOS™	2 x 65.00	20	3.50	1.20 ... 2.20	10.00	Logic	TDSON-8-10

Automotive N-Channel MOSFETs

60 V (Planar)



Product name	Technology	$R_{DS(on)}$ @ 10 V [mΩ]	I_D [A]	R_{thJC} (max) [K/W]	$V_{GS(th)}$ (min-max) [V]	Q_G (typ) [nC]	Normal/logic level	Package
AUIRF7478Q	Gen 7	26	7	20	1.00 ... 3.00	21	Logic	SO-8 (DSO-8)

75 V (Planar)



Product name	Technology	$R_{DS(on)}$ @ 10 V [mΩ]	I_D [A]	R_{thJC} (max) [K/W]	$V_{GS(th)}$ (min-max) [V]	Q_G (typ) [nC]	Normal/logic level	Package
AUIRFP2907	Gen 7	4.50	90	0.32	2.00 ... 4.00	410	Normal	TO-247
IPB100N08S2L-07	OptiMOS™	6.50	100	0.50	1.20 ... 2.00	185	Logic	TO263-3-2 (TO220-3 (SMD))
IPB100N08S2-07	OptiMOS™	6.80	100	0.50	2.10 ... 4.00	153	Normal	TO263-3-2 (TO220-3 (SMD))
IPB80N08S2L-07	OptiMOS™	6.80	80	0.50	1.20 ... 2.00	186	Logic	TO263-3-2 (TO220-3 (SMD))
IPP100N08S2L-07	OptiMOS™	6.80	100	0.50	1.20 ... 2.00	182	Logic	TO220-3
IPB80N08S2-07	OptiMOS™	7.10	80	0.50	2.10 ... 4.00	182	Normal	TO263-3-2 (TO220-3 (SMD))
IPP100N08S2-07	OptiMOS™	7.10	100	0.50	2.10 ... 4.00	144	Normal	TO220-3
IPI100N08S2-07	OptiMOS™	7.10	100	0.50	2.10 ... 4.00	144	Normal	TO262-3
IPP80N08S2L-07	OptiMOS™	7.10	80	0.50	1.20 ... 2.00	183	Logic	TO220-3
IPI80N08S2-07	OptiMOS™	7.40	80	0.50	2.10 ... 4.00	144	Normal	TO262-3
AUIRF3007	Gen 7	12.60	75	0.74	2.00 ... 4.00	89	Normal	TO-220
AUIRF2807	Gen 7	13.00	75	0.65	2.00 ... 4.00	107	Normal	TO-220
IPD30N08S2L-21	OptiMOS™	20.50	30	1.10	1.20 ... 2.00	43	Logic	TO252-3 (DPAK)
IPD30N08S2-22	OptiMOS™	21.50	30	1.10	2.10 ... 4.00	44	Normal	TO252-3 (DPAK)
IPD22N08S2L-50	OptiMOS™	50.00	22	2.00	1.20 ... 2.00	21	Logic	TO252-3 (DPAK)

100 V (Planar)



Product name	Technology	$R_{DS(on)}$ @ 10 V [mΩ]	I_D [A]	R_{thJC} (max) [K/W]	$V_{GS(th)}$ (min-max) [V]	Q_G (typ) [nC]	Normal/logic level	Package
AUIRLR3410	Gen 5	105	15	1.90	1.00 ... 2.00	23	Logic	TO-252 (DPAK 3-leg)
AUIRLR120N	Gen 5	185	11	3.10	1.00 ... 2.00	13	Logic	TO-252 (DPAK 3-leg)

150 V (Planar)



Product name	Technology	$R_{DS(on)}$ @ 10 V [mΩ]	I_D [A]	R_{thJC} (max) [K/W]	$V_{GS(th)}$ (min-max) [V]	Q_G (typ) [nC]	Normal/logic level	Package
AUIRF3415	Gen 5	42	43	0.75	2.00 ... 4.00	133	Normal	TO-220
AUIRF3315S	Gen 5	82	21	1.60	2.00 ... 4.00	63	Normal	TO-263-3 (D ² PAK 3-leg)

Automotive P-Channel MOSFETs

30 V (Trench)



Product name	Technology	$R_{DS(on)}$ @ 10 V [mΩ]	I_D [A]	R_{thJC} (max) [K/W]	$V_{GS(th)}$ (min-max) [V]	Q_G (typ) [nC]	Normal/logic level	Package
IPB80P03P4L-04	OptiMOS™-P2	4.10	-80	1.10	-2.00 ... -1.00	125	Logic	TO263-3-2 (TO220-3 (SMD))
IPI80P03P4L-04	OptiMOS™-P2	4.40	-80	1.10	-2.00 ... -1.00	125	Logic	TO262-3
IPP80P03P4L-04	OptiMOS™-P2	4.40	-80	1.10	-2.00 ... -1.00	125	Logic	TO220-3
IPD90P03P4L-04	OptiMOS™-P2	4.50	-90	1.10	-2.00 ... -1.00	100	Logic	TO252-3 (DPAK)
IPD90P03P4-04	OptiMOS™-P2	4.50	-90	1.10	-4.00 ... -2.00	100	Normal	TO252-3 (DPAK)
IPB80P03P4-05	OptiMOS™-P2	4.70	-80	1.10	-4.00 ... -2.00	100	Normal	TO263-3-2 (TO220-3 (SMD))
IPI80P03P4-05	OptiMOS™-P2	5.00	-80	1.10	-4.00 ... -2.00	100	Normal	TO262-3
IPP80P03P4-05	OptiMOS™-P2	5.00	-80	1.10	-4.00 ... -2.00	100	Normal	TO220-3
IPD80P03P4L-07	OptiMOS™-P2	6.80	-80	1.70	-2.00 ... -1.00	80	Logic	TO252-3 (DPAK)
IPB80P03P4L-07	OptiMOS™-P2	6.90	-80	1.70	-2.00 ... -1.00	63	Logic	TO263-3-2 (TO220-3 (SMD))
IPI80P03P4L-07	OptiMOS™-P2	7.20	-80	1.70	-2.00 ... -1.00	63	Logic	TO262-3
IPP80P03P4L-07	OptiMOS™-P2	7.20	-80	1.70	-2.00 ... -1.00	63	Logic	TO220-3
IPD50P03P4L-11	OptiMOS™-P2	10.50	-50	2.60	-2.00 ... -1.00	42	Logic	TO252-3 (DPAK)
IPB45P03P4L-11	OptiMOS™-P2	10.80	-45	2.60	-2.00 ... -1.00	42	Logic	TO263-3-2 (TO220-3 (SMD))
IPP45P03P4L-11	OptiMOS™-P2	11.10	-45	2.60	-2.00 ... -1.00	42	Logic	TO220-3

40 V (Trench)



Product name	Technology	$R_{DS(on)}$ @ 10 V [mΩ]	I_D [A]	R_{thJC} (max) [K/W]	$V_{GS(th)}$ (min-max) [V]	Q_G (typ) [nC]	Normal/logic level	Package
IPB180P04P4L-02	OptiMOS™-P2	2.40	-100	1.00	-2.20 ... -1.70	220	Logic	TO263-7-3 (TO220-7 (SMD))
IPB180P04P4-03	OptiMOS™-P2	2.80	-100	1.00	-4.00 ... -2.00	190	Normal	TO263-7-3 (TO220-7 (SMD))
IPB120P04P4L-03	OptiMOS™-P2	3.00	-120	1.10	-2.20 ... -1.70	180	Logic	TO263-3-2 (TO220-3 (SMD))
IPP120P04P4L-03	OptiMOS™-P2	3.40	-120	1.10	-2.20 ... -1.70	180	Logic	TO220-3
IPI120P04P4L-03	OptiMOS™-P2	3.40	-120	1.10	-2.20 ... -1.70	180	Logic	TO262-3
IPB120P04P4-04	OptiMOS™-P2	3.60	-120	1.10	-4.00 ... -2.00	158	Normal	TO263-3-2 (TO220-3 (SMD))
IPP120P04P4-04	OptiMOS™-P2	3.90	-120	1.10	-4.00 ... -2.00	158	Normal	TO220-3
IPI120P04P4-04	OptiMOS™-P2	3.90	-120	1.10	-4.00 ... -2.00	135	Normal	TO262-3
IPB80P04P4L-04	OptiMOS™-P2	4.20	-90	1.20	-2.20 ... -1.70	135	Logic	TO263-3-2 (TO220-3 (SMD))
IPD90P04P4L-04	OptiMOS™-P2	4.30	-90	1.20	-2.20 ... -1.70	135	Logic	TO252-3 (DPAK)
IPD90P04P4-05	OptiMOS™-P2	4.70	-90	1.20	-4.00 ... -2.00	118	Normal	TO252-3 (DPAK)
IPP80P04P4L-04	OptiMOS™-P2	4.70	-80	1.20	-2.20 ... -1.70	16	Logic	TO220-3
IPI80P04P4L-04	OptiMOS™-P2	4.70	-80	1.20	-2.20 ... -1.70	16	Logic	TO262-3
IPB80P04P4-05	OptiMOS™-P2	4.90	-80	1.20	-4.00 ... -2.00	118	Normal	TO263-3-2 (TO220-3 (SMD))
IPI80P04P4-05	OptiMOS™-P2	5.20	-80	1.20	-4.00 ... -2.00	14	Normal	TO262-3
IPB80P04P4L-06	OptiMOS™-P2	6.40	-80	1.70	-2.20 ... -1.70	71	Logic	TO263-3-2 (TO220-3 (SMD))
IPD85P04P4L-06	OptiMOS™-P2	6.40	-85	1.70	-2.20 ... -1.70	80	Logic	TO252-3 (DPAK)
IPP80P04P4L-06	OptiMOS™-P2	6.70	-80	1.70	-2.20 ... -1.70	71	Logic	TO220-3
IPI80P04P4L-06	OptiMOS™-P2	6.70	-80	1.70	-2.20 ... -1.70	71	Logic	TO262-3
IPB80P04P4-07	OptiMOS™-P2	7.30	-80	1.70	-4.00 ... -2.00	71	Normal	TO263-3-2 (TO220-3 (SMD))
IPD85P04P4-07	OptiMOS™-P2	7.30	-85	1.70	-4.00 ... -2.00	69	Normal	TO252-3 (DPAK)
IPP80P04P4-07	OptiMOS™-P2	7.60	-80	1.70	-4.00 ... -2.00	71	Normal	TO220-3
IPI80P04P4-07	OptiMOS™-P2	7.60	-80	1.70	-4.00 ... -2.00	71	Normal	TO262-3
IPD70P04P4L-08	OptiMOS™-P2	7.80	-70	2.00	-2.20 ... -1.70	63	Logic	TO252-3 (DPAK)
IPP80P04P4L-08	OptiMOS™-P2	7.90	-80	2.00	-1.20 ... -2.20	71	Logic	TO220-3
IPD70P04P4-09	OptiMOS™-P2	8.90	-70	2.00	-4.00 ... -2.00	54	Normal	TO252-3 (DPAK)
IPB70P04P4-09	OptiMOS™-P2	9.30	-70	2.00	-4.00 ... -2.00	54	Normal	TO263-3-2 (TO220-3 (SMD))
IPI70P04P4-09	OptiMOS™-P2	9.40	-70	2.00	-4.00 ... -2.00	54	Normal	TO262-3
IPD50P04P4L-11	OptiMOS™-P2	10.60	-50	2.60	-2.20 ... -1.70	45	Logic	TO252-3 (DPAK)
IPD50P04P4-13	OptiMOS™-P2	12.60	-50	2.60	-4.00 ... -2.00	39	Normal	TO252-3 (DPAK)

Automotive P-Channel MOSFETs

20 V (Planar)



Product name	Technology	$R_{DS(on)}$ @ 10 V [m Ω]	I_D [A]	R_{thJC} (max) [K/W]	$V_{GS(th)}$ (min-max) [V]	Q_G (typ) [nC]	Normal/ logic level	Package
AUIRF7207Q	Gen 5	60	-5.00	n/a	-1.60 ... -0.70	15	Logic	SO-8 (DSO-8)
AUIRF7304Q	Gen 5	2 x 90	-4.30	n/a	-1.60 ... -0.70	15	Logic	SO-8 (DSO-8)

30 V (Planar)



Product name	Technology	$R_{DS(on)}$ @ 10 V [m Ω]	I_D [A]	R_{thJC} (max) [K/W]	$V_{GS(th)}$ (min-max) [V]	Q_G (typ) [nC]	Normal/ logic level	Package
AUIRF7416Q	Gen 5	20	-10.00	n/a	-2.00 ... -1.00	61	Logic	SO-8 (DSO-8)
AUIRF7316Q	Gen 5	2 x 58	-4.90	n/a	-3.00 ... -1.00	23	Logic	SO-8 (DSO-8)

55 V (Planar)



Product name	Technology	$R_{DS(on)}$ @ 10 V [m Ω]	I_D [A]	R_{thJC} (max) [K/W]	$V_{GS(th)}$ (min-max) [V]	Q_G (typ) [nC]	Normal/ logic level	Package
AUIRF4905	Gen 5	20	-74.00	0.75	-4.00 ... -2.00	120	Normal	TO-220
AUIRF4905L	Gen 5	20	-74.00	0.75	-4.00 ... -2.00	120	Normal	TO-262
AUIRF4905S	Gen 5	20	-74.00	0.75	-4.00 ... -2.00	120	Normal	TO-263-3 (D ² PAK 3-leg)
AUIRF5305	Gen 5	65	-28.00	1.40	-4.00 ... -2.00	42	Normal	TO-252 (DPAK 3-leg)
AUIRF9Z34N	Gen 5	100	-17.00	2.20	-4.00 ... -2.00	23	Normal	TO-220
AUIRF5505	Gen 5	110	-18.00	2.20	-4.00 ... -2.00	21	Normal	TO-252 (DPAK 3-leg)
AUIRF9024N	Gen 5	175	-11.00	3.30	-4.00 ... -2.00	13	Normal	TO-252 (DPAK 3-leg)
AUIRF7342Q	Gen 5	2 x 105	-3.40	n/a	-3.00 ... -1.00	26	Logic	SO-8 (DSO-8)

100 V (Planar)



Product name	Technology	$R_{DS(on)}$ @ 10 V [m Ω]	I_D [A]	R_{thJC} (max) [K/W]	$V_{GS(th)}$ (min-max) [V]	Q_G (typ) [nC]	Normal/ logic level	Package
AUIRF5210S	Gen 5	60	-38	0.75	-4.00 ... -2.00	150	Normal	TO-263-3 (D ² PAK 3-leg)
AUIRF9540N	Gen 5	117	-23	1.10	-4.00 ... -2.00	65	Normal	TO-220
AUIRF5410	Gen 5	205	-13	1.90	-4.00 ... -2.00	39	Normal	TO-252 (DPAK 3-leg)

150 V (Planar)



Product name	Technology	$R_{DS(on)}$ @ 10 V [m Ω]	I_D [A]	R_{thJC} (max) [K/W]	$V_{GS(th)}$ (min-max) [V]	Q_G (typ) [nC]	Normal/ logic level	Package
AUIRF6218S	Gen 5	150	-27	0.61	-5.00 ... -3.00	71	Normal	TO-263-3 (D ² PAK 3-leg)
AUIRF6215S	Gen 5	290	-13	1.40	-4.00 ... -2.00	44	Normal	TO-263-3 (D ² PAK 3-leg)
AUIRF6215	Gen 5	295	-13	1.40	-4.00 ... -2.00	44	Normal	TO-252 (DPAK 3-leg)
AUIRF6215	Gen 5	290	-13	1.40	-4.00 ... -2.00	44	Normal	TO-220

Automotive N+P-Channel MOSFETs

30 V (Planar)



Product name	Technology	$R_{DS(on)}$ @ 10 V [mΩ]	I_D [A]	$V_{GS(th)}$ (min-max) [V]	Q_G (typ) [nC]	Normal/ logic level	Package
AUIRF7319Q	Gen 5	29/58	5.80/-4.90	1.00 ... 3.00	22.00/23.00	Logic	SO-8 (DSO-8)
AUIRF7379Q	Gen 5	45/90	5.80/-4.30	1.00 ... 3.00	25.00/25.00	Logic	SO-8 (DSO-8)
AUIRF7309Q	Gen 5	50/100	4.70/-3.50	1.00 ... 3.00	25.00/25.00	Logic	SO-8 (DSO-8)
AUIRF9952Q	Gen 5	100/250	3.50/-2.30	1.00 ... 3.00	6.90/6.10	Logic	SO-8 (DSO-8)

55 V (Planar)



Product name	Technology	$R_{DS(on)}$ @ 10 V [mΩ]	I_D [A]	$V_{GS(th)}$ (min-max) [V]	Q_G (typ) [nC]	Normal/ logic level	Package
AUIRF7343Q	Gen 5	50/105	4.70/-3.40	1.00 ... 3.00	24/26	Logic	SO-8 (DSO-8)

Small Signal MOSFETs

Infineon offers a full range of Small Signal MOSFETs qualified according AEC-Q101.

The portfolio includes

- > Polarity: N-Channel enhancement, N-Channel depletion and P-Channel MOSFETs
- > Voltage classes: -250 ... 800 V
- > V_{GS} rating: 10 V (normal level), 4.5 V (logic level), 2.5 V (super logic level), 1.8 V (ultra logic level)
- > Packages: SOT223, SOT89, TSOP-6 (single and dual), SC59, SOT23, SOT323, SOT363 (single and dual)
- > Configuration: single, dual, complementary (n+p pairs)
- > Additional features: the products with names ending with "E" have an Integrated ESD protection

SC59 is an enhanced version of the SOT23: it's footprint compatible with SOT23, but allows a bigger chip inside, therefore a lower $R_{DS(on)}$.

Naming system

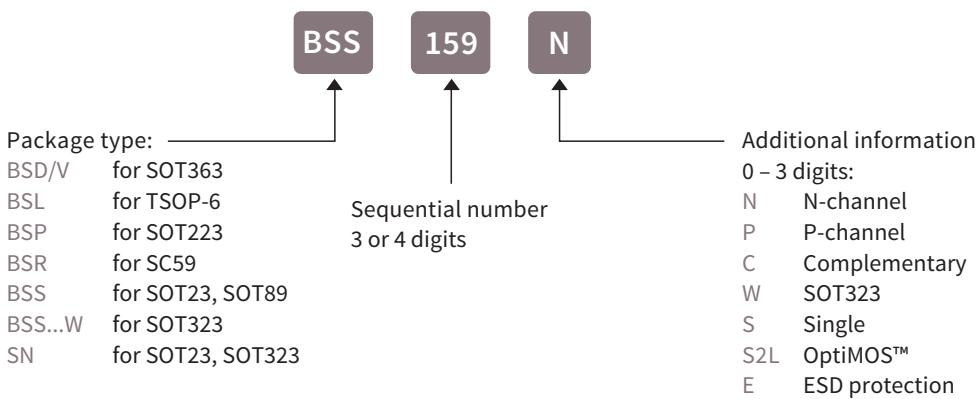

www.infineon.com/smallsignalmosfets
www.infineon.com/complementary
www.infineon.com/pchannel
www.infineon.com/depletion

N-Channel MOSFETs

Voltage	Product name	$R_{DS(on)}$ @ 10 V [mΩ]	I_D [A]	$V_{GS(th)}$ (min-max) [V]	Q_G (typ) [nC]	Technology	Package
20 V	BSL802SN	22 ²⁾	7.50	0.30 ... 0.75	4.70	OptiMOS™2	TSOP-6/6 dual
	BSL202SN	22 ¹⁾	7.50	0.70 ... 1.20	5.80	OptiMOS™2	TSOP-6/6 dual
	BSL205N	50 ¹⁾	2.50	0.70 ... 1.20	2.10	OptiMOS™2	TSOP-6/6 dual
	BSL214N	140 ¹⁾	1.50	0.70 ... 1.20	0.80	OptiMOS™2	TSOP-6/6 dual
	BSL207N	70 ¹⁾	2.10	0.70 ... 1.20	2.10	OptiMOS™2	TSOP-6/6 dual
	BSL806N	57 ²⁾	2.30	0.30 ... 0.75	1.70	OptiMOS™2	TSOP-6/6 dual
	BSR202N	21 ¹⁾	3.80	0.70 ... 1.20	5.80	OptiMOS™2	SC59
	BSR802N	23 ²⁾	3.70	0.30 ... 0.75	4.70	OptiMOS™2	SC59
	BSS205N	50 ¹⁾	2.50	0.70 ... 1.20	2.10	OptiMOS™2	SOT23
	BSS214N	140 ¹⁾	1.50	0.70 ... 1.20	0.80	OptiMOS™2	SOT23
	BSS806N	57 ²⁾	2.30	0.30 ... 0.75	1.70	OptiMOS™2	SOT23
	BSS816NW	160 ²⁾	1.40	0.30 ... 0.75	0.60	OptiMOS™2	SOT323
	BSS214NW	140 ¹⁾	1.50	0.70 ... 1.20	0.80	OptiMOS™2	SOT323
	BSD214SN	140 ¹⁾	1.50	0.70 ... 1.20	0.80	OptiMOS™2	SOT363
	BSD816SN	160 ²⁾	1.40	0.30 ... 0.75	0.60	OptiMOS™2	SOT363
BSD235N	350 ¹⁾	0.95	0.70 ... 1.20	0.32	OptiMOS™2	SOT363	
BSD840N	400 ²⁾	0.88	0.30 ... 0.75	0.26	OptiMOS™2	SOT363	
30 V	BSR302N	23	3.70	1.20 ... 2.00	4.40	OptiMOS™2	SC59
	BSL302SN	25	7.10	1.20 ... 2.00	4.40	OptiMOS™2	TSOP-6/6 dual
	BSL306N	57	2.30	1.20 ... 2.00	1.60	OptiMOS™2	TSOP-6/6 dual
	BSS306N	57	2.30	1.20 ... 2.00	1.50	OptiMOS™2	SOT23
	BSS316N	160	1.40	1.20 ... 2.00	0.60	OptiMOS™2	SOT23
55 V	BSD316SN	160	1.40	1.20 ... 2.00	0.60	OptiMOS™2	SOT363
	BSS670S2L	650	0.54	1.20 ... 2.00	1.70	OptiMOS™	SOT23
	BSS606N	60	3.20	1.30 ... 2.30	6.10	OptiMOS™3	SOT89
	BSL606SN	60	4.50	1.30 ... 2.30	6.10	OptiMOS™3	TSOP-6/6 dual
	BSR606N	60	2.40	1.30 ... 2.30	6.10	OptiMOS™3	SC59
	BSP318S	90	2.60	1.20 ... 2.00	14.00	SIPMOS™	SOT223
	BSP320S	120	2.90	2.10 ... 4.00	9.70	SIPMOS™	SOT223
	BSP295	300	1.80	0.80 ... 1.80	14.00	SIPMOS™	SOT223
	2N7002DW	3000	0.30	1.50 ... 2.50	0.40	OptiMOS™	SOT363
	BSS138N	3500	0.23	0.60 ... 1.40	1.00	SIPMOS™	SOT23
	BSS138W	3500	0.28	0.60 ... 1.40	1.00	SIPMOS™	SOT223
	SN7002N	5000	0.20	0.80 ... 1.80	1.00	SIPMOS™	SOT23
	BSS7728N	5000	0.20	1.30 ... 2.30	1.00	SIPMOS™	SOT23
	SN7002W	5000	0.23	0.80 ... 1.80	1.00	SIPMOS™	SOT323
	100 V	BSL372SN	220	2.00	4.50	9.50	SIPMOS™
BSP372N		230	1.80	0.80 ... 2.00	9.50	SIPMOS™	SOT223
BSL373SN		230	2.00	10.00	6.20	SIPMOS™	TSOP-6/6 dual
BSP373N		240	1.80	2.10 ... 4.00	6.20	SIPMOS™	SOT223
BSL296SN		460	1.40	4.50	4.50	SIPMOS™	TSOP-6/6 dual
BSP296N		600	1.20	0.80 ... 1.80	4.50	SIPMOS™	SOT223
BSS123N		6000	0.19	0.80 ... 1.80	0.60	SIPMOS™	SOT23
200 V	BSS119N	6000	0.19	1.80 ... 2.30	0.60	SIPMOS™	SOT23
	BSP297	1800	0.66	0.80 ... 1.80	12.90	SIPMOS™	SOT223
240 V	BSP89	6000	0.35	0.80 ... 1.80	4.30	SIPMOS™	SOT223
	BSP88	6000	0.35	0.60 ... 1.40	4.50	SIPMOS™	SOT223
	BSS87	6000	0.26	0.80 ... 1.80	3.70	SIPMOS™	SOT89
	BSS131	14,000	0.11	0.80 ... 1.80	2.10	SIPMOS™	SOT23
400 V	BSP298	3000	0.50	2.10 ... 4.00	–	SIPMOS™	SOT223
	BSP324	25,000	0.17	1.30 ... 2.30	4.50	SIPMOS™	SOT223
500 V	BSP299	4000	0.400	2.10 ... 4.00	–	SIPMOS™	SOT223

1) $R_{DS(on)}$ @ 4.5 V

2) $R_{DS(on)}$ @ 2.5 V

www.infineon.com/smallsignalmosfets

www.infineon.com/complementary

www.infineon.com/pchannel

www.infineon.com/depletion

Small Signal MOSFETs

N-Channel MOSFETs (cont'd)

Voltage	Product name	$R_{DS(on)}$ @ 10 V [mΩ]	I_D [A]	$V_{GS(th)}$ (min-max) [V]	Q_G (typ) [nC]	Technology	Package
600 V	BSP125	45,000	0.120	1.30 ... 2.30	4.40	SIPMOST™	SOT223
	BSS225	45,000	0.090	1.30 ... 2.30	3.90	SIPMOST™	SOT89
	BSS127	500,000	0.023	1.40 ... 2.60	1.40	SIPMOST™	SOT23
800 V	BSP300	20	0.190	2.10 ... 4.00	–	SIPMOST™	SOT223

P-Channel MOSFETs

Voltage	Product name	$R_{DS(on)}$ @ 10 V [mΩ]	I_D [A]	$V_{GS(th)}$ (min-max) [V]	Q_G (typ) [nC]	Technology	Package
-20 V	BSL207SP	–	-6.00	-1.20 ... -0.60	-13.30	OptiMOS™2 P	TSOP-6/6 dual
	BSL211SP	–	-4.70	-1.20 ... -0.60	-8.30	OptiMOS™2 P	TSOP-6/6 dual
	BSL215P	–	-1.50	-1.20 ... -0.60	-3.55	OptiMOS™2 P	TSOP-6/6 dual
	BSS215P	–	-1.50	-1.20 ... -0.50	-3.60	OptiMOS™2 P	SOT23
	BSS209PW	–	-0.58	-1.20 ... -0.60	-0.92	OptiMOS™2 P	SOT323
	BSS223PW	–	-0.39	-1.20 ... -0.60	-0.50	OptiMOS™2 P	SOT323
	BSV236SP	–	-1.50	-1.20 ... -0.60	-3.80	OptiMOS™ P	SOT363
	BSD223P	–	-0.39	-1.20 ... -0.60	-0.50	OptiMOS™2 P	SOT363
-30 V	BSL307SP	43	-5.50	-2.00 ... -1.00	-23.40	OptiMOS™2 P	TSOP-6/6 dual
	BSL308PE	80	-2.10	-2.00 ... -1.00	-2.90	OptiMOS™3 P + integrated ESD diode	TSOP-6/6 dual
	BSL314PE	140	-1.50	-2.00 ... -1.00	-2.30	OptiMOS™3 P + integrated ESD diode	TSOP-6/6 dual
	BSS308PE	80	-2.10	-2.00 ... -1.00	-5.20	OptiMOS™3 P + integrated ESD diode	SOT23
	BSS314PE	140	-1.50	-2.00 ... -1.00	-2.90	OptiMOS™3 P + integrated ESD diode	SOT23
	BSS315P	150	-1.50	-2.00 ... -1.00	-2.30	OptiMOS™2 P	SOT23
	BSD314SPE	140	-1.50	-2.00 ... -1.00	-2.90	OptiMOS™3 P + integrated ESD diode	SOT363
	BSL303SPE	30	-6.60	4.50	–	OptiMOS™ P + integrated ESD diode	TSOP-6/6 dual
BSL305SPE	50	-5.30	4.50	–	TSOP-6/6 dual		
-60 V	BSP613P	130	-2.90	-4.00 ... -2.10	-22.00	SIPMOST™	SOT223
	BSP170P	300	-1.90	-4.00 ... -2.10	-10.00	SIPMOST™	SOT223
-60 V	BSP171P	300	-1.90	-2.00 ... -1.00	-13.00	SIPMOST™	SOT223
	BSP315P	800	-1.17	-2.00 ... -1.00	-5.20	SIPMOST™	SOT223
	BSR315P	800	-0.62	-2.00 ... -1.00	-4.00	SIPMOST™	SC59
	BSS83P	2000	-0.33	-2.00 ... -1.00	-2.38	SIPMOST™	SOT23
	BSS84P	8000	-0.17	-2.00 ... -1.00	-1.00	SIPMOST™	SOT23
	BSS84PW	8000	-0.15	-2.00 ... -1.00	-1.00	SIPMOST™	SOT323
-100 V	BSP322P	800	-1.00	-2.00 ... -1.00	-12.40	SIPMOST™	SOT223
	BSP321P	900	-0.98	-4.00 ... -2.10	-9.00	SIPMOST™	SOT223
	BSP316P	1800	-0.68	-2.00 ... -1.00	-5.10	SIPMOST™	SOT223
	BSR316P	1800	-0.36	-2.00 ... -1.00	-3.00	SIPMOST™	SC59

www.infineon.com/smallsignalmosfets

www.infineon.com/complementary

www.infineon.com/pchannel

www.infineon.com/depletion

P-Channel MOSFETs (cont'd)

Voltage	Product name	$R_{DS(on)}$ @ 10 V [mΩ]	I_D [A]	$V_{GS(th)}$ (min-max) [V]	Q_G (typ) [nC]	Technology	Package
-250 V	BSP317P	4000	-0.43	-2.00 ... -1.00	-11.60	SIPMOST™	SOT223
	BSP92P	12,000	-0.26	-2.00 ... -1.00	-4.30	SIPMOST™	SOT223
	BSS192P	12,000	-0.19	-2.00 ... -1.00	-4.90	SIPMOST™	SOT89
	BSR92P	11,000	-0.14	-2.00 ... -1.00	-3.60	SIPMOST™	SC59

Complementary MOSFETs

Voltage	Product name	$R_{DS(on)}$ (max) @ $V_{GS} = -10$ V [mΩ]	I_D [A]	$V_{GS(th)}$ (min-max) [V]	Q_G (typ) [nC]	Technology	Package
20 V	BSL215C/n-ch	-	1.50	0.70 ... 1.20	0.73	OptiMOS™2	TSOP-6/6 dual
-20 V	BSL215C/p-ch	-	-1.50	-1.20 ... -0.60	-3.00	OptiMOS™2 P	TSOP-6/6 dual
20 V	BSD235C/n-ch	-	0.95	-1.20 ... -0.60	0.34	OptiMOS™2	SOT363
-20 V	BSD235C/p-ch	-	-0.53	0.70 ... 1.20	-0.40	OptiMOS™2 P	SOT363
20 V	BSZ15DC02KD/n-ch	-	5.10	0.80 ... 1.40	2.10	OptiMOS™2	TSDSON-8 dual
-20 V	BSZ15DC02KD/p-ch	-	-3.20	-1.40 ... -0.70	-3.00	OptiMOS™2 P	TSDSON-8 dual
30 V	BSL316C/n-ch	160	1.40	-2.00 ... -1.00	0.60	OptiMOS™2	TSOP-6/6 dual
-30 V	BSL316C/p-ch	150	-1.50	1.20 ... 2.00	-2.40	OptiMOS™2 P	TSOP-6/6 dual
30 V	BSL308C/n-ch	57	2.30	1.20 ... 2.00	1.50	OptiMOS™2	TSOP-6/6 dual
-30 V	BSL308C/p-ch	80	-2.10	-2.00 ... -1.00	-2.90	OptiMOS™3 P	TSOP-6/6 dual

Depletion MOSFETs

Voltage	Product name	$R_{DS(on)}$ (max) @ $V_{GS} = 0$ V [mΩ]	I_D [A]	Q_G (typ) [nC]	Technology	Package
60 V	BSS159N	8.00	0.130	2.20	SIPMOST™	SOT23
100 V	BSS169	12.00	0.090	2.10	SIPMOST™	SOT23
200 V	BSP149	3.50	0.140	11.00	SIPMOST™	SOT223
240 V	BSP129	20.00	0.050	3.80	SIPMOST™	SOT223
250 V	BSS139	30.00	0.030	2.30	SIPMOST™	SOT23
400 V	BSP179	24.00	0.040	3.70	SIPMOST™	SOT223
600 V	BSP135	60.00	0.020	3.70	SIPMOST™	SOT223
	BSS126	700.00	0.007	1.40	SIPMOST™	SOT23

www.infineon.com/smallsignalmosfets

www.infineon.com/complementary

www.infineon.com/pchannel

www.infineon.com/depletion

Power MOSFETs

600 V CoolMOS™ CPA and 650 V CoolMOS™ CFDA

Following the release of the first series of high-voltage automotive MOSFETs – the 600 V CoolMOS™ CPA series – Infineon has launched its second generation of market-leading, automotive-qualified, high-voltage MOSFETs, the 650 V CoolMOS™ CFDA series. Whereas the first generation of 600 V CoolMOS™ CPA series addresses the well-known attributes of high quality and reliability required by the automotive industry, the newer 650 V CoolMOS™ CFDA series also caters to special application needs with its integrated fast body diode. This fast body diode is the key for addressing resonant switching topologies, resulting in lower switching losses due to the low gate charge. The softer commutation behavior and consequent reduced EMI appearance gives the 650 V CoolMOS™ CFDA series a clear advantage in comparison with competitor parts. Furthermore, limited voltage

overshoot during hard commutation of the body diode enables easier implementation of layout and design.

The basic 600 V CoolMOS™ CPA portfolio is complemented with the broad 650 V CoolMOS™ CFDA portfolio which provides all the benefits of a fast-switching Super-Junction MOSFET fulfilling the enhanced reliability requirements for automotive applications realized with special screening measures in front end and back end as well as the qualification compliant to AEC-Q100.

Therefore, the combination of both technologies – the 600 V CoolMOS™ CPA and the new 650 V CoolMOS™ CFDA technology – is the best choice for switching topologies in automotive applications.

Common key features CoolMOS™ “A”

- > First 600 V/650 V automotive-qualified high-voltage technologies for the automotive market
- > Compliant to AEC-Q101 standard

Key features 600 V CoolMOS™ CPA

- > Lowest $R_{DS(on)}$ per package
- > Lowest gate charge value Q_g

Key feature 650 V CoolMOS™ CFDA

- > Limited voltage overshoot during hard commutation – self-limiting di/dt and dv/dt
- > Low Q_{rr} at repetitive commutation on body diode and low Q_{oss}

Applications 600 V CoolMOS™ CPA

- > Hard switching topologies
- > PFC boost stages in on-board charger
- > Active clamp or 2-transistor forward in DC-DC converter

Application 650 V CoolMOS™ CFDA

- > Resonant switching topologies
- > LLC or full-bridge ZVS in DC-DC converter
- > HID lamp



Naming system

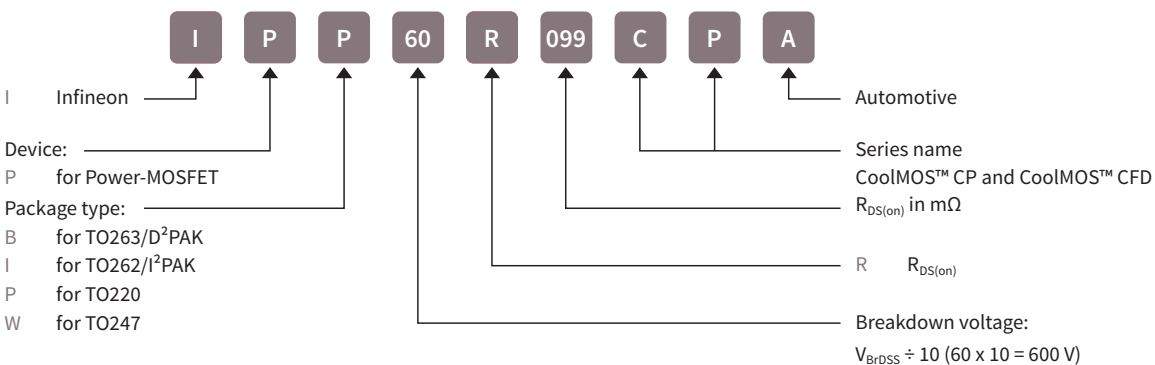

Example for automotive topology using CoolMOS™ CFDA

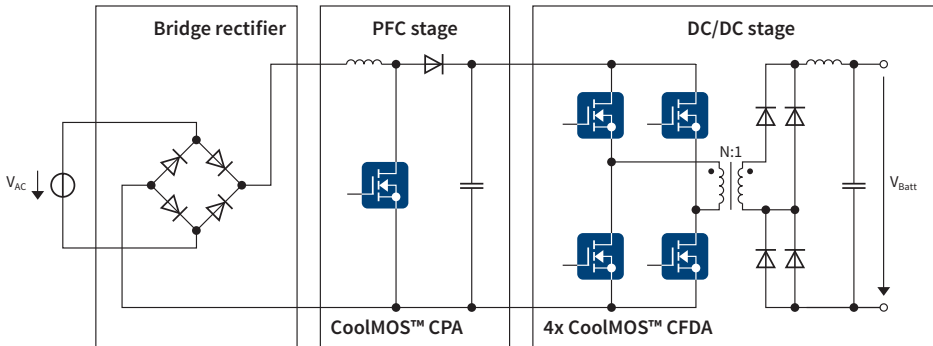

On-board battery charger with ZVS phase shifted topology

600 V CoolMOS™ CPA product portfolio

Product name	$R_{DS(on)}$ @ $T_j = 25^\circ\text{C}$ $V_{GS} = 10\text{ V}$ [mΩ]	I_D (max) @ $T_j = 25^\circ\text{C}$ [A]	I_{Dpuls} (max) [A]	$V_{GS(th)}$ (min-max) [V]	Q_G (typ) [nC]	R_{thJC} (max) [K/W]	Package
IPB60R099CPA	105	31	93	-20 ... 20	60	0.50	TO263-3-2 (TO220-3 (SMD))
IPB60R199CPA	199	16	51	-20 ... 20	32	0.90	TO263-3-2 (TO220-3 (SMD))
IPB60R299CPA	299	11	34	-20 ... 20	22	1.30	TO263-3-2 (TO220-3 (SMD))
IPP60R099CPA	105	31	93	-20 ... 20	60	0.50	TO220-3
IPW60R045CPA	45	60	230	-20 ... 10	150	0.29	TO247-3
IPW60R075CPA	75	39	130	-20 ... 20	87	0.40	TO247-3
IPW60R099CPA	105	31	93	-20 ... 20	60	0.50	TO247-3
IPI60R099CPA	105	31	93	-20 ... 20	60	0.50	TO262-3

650 V CoolMOS™ CFDA product portfolio

Product name	$R_{DS(on)}$ @ $T_j = 25^\circ\text{C}$ $V_{GS} = 10\text{ V}$ [mΩ]	I_D (max) @ $T_j = 25^\circ\text{C}$ [A]	I_{Dpuls} (max) [A]	$V_{GS(th)}$ (min-max) [V]	Q_G (typ) [nC]	R_{thJC} (max) [K/W]	Package
IPD65R420CFDA	420	8.70	27.00	3.50 ... 4.50	32	1.50	TO252-3 (DPAK)
IPD65R660CFDA	660	6.00	17.00	3.50 ... 4.50	20	2.00	TO252-3 (DPAK)
IPB65R110CFDA	110	31.20	99.60	3.50 ... 4.50	118	0.45	TO263-3-2 (TO220-3 (SMD))
IPB65R150CFDA	150	22.40	72.00	3.50 ... 4.50	86	0.64	TO263-3-2 (TO220-3 (SMD))
IPB65R190CFDA	190	17.50	57.20	3.50 ... 4.50	68	0.83	TO263-3-2 (TO220-3 (SMD))
IPB65R310CFDA	310	11.40	34.40	3.50 ... 4.50	41	1.20	TO263-3-2 (TO220-3 (SMD))
IPB65R660CFDA	660	6.00	17.00	3.50 ... 4.50	20	2.00	TO263-3-2 (TO220-3 (SMD))
IPP65R110CFDA	110	31.20	99.60	3.50 ... 4.50	118	0.45	TO220-3
IPP65R150CFDA	150	22.40	72.00	3.50 ... 4.50	86	0.64	TO220-3
IPP65R190CFDA	190	17.50	57.20	3.50 ... 4.50	68	0.83	TO220-3
IPP65R310CFDA	310	11.40	34.40	3.50 ... 4.50	41	1.20	TO220-3
IPP65R660CFDA	660	6.00	17.00	3.50 ... 4.50	20	2.00	TO220-3
IPW65R048CFDA	48	63.30	228.00	3.50 ... 4.50	270	0.25	TO247-3
IPW65R080CFDA	80	43.30	127.00	3.50 ... 4.50	161	0.32	TO247-3
IPW65R110CFDA	110	31.20	99.60	3.50 ... 4.50	118	0.45	TO247-3
IPW65R150CFDA	150	22.40	72.00	3.50 ... 4.50	86	0.64	TO247-3
IPW65R190CFDA	190	17.50	57.20	3.50 ... 4.50	68	0.83	TO247-3

Where to buy

Infineon distribution partners and sales offices:

www.infineon.com/WhereToBuy

Service hotline

Infineon offers its toll-free 0800/4001 service hotline as one central number, available 24/7 in English, Mandarin and German.

- > Germany 0800 951 951 951 (German/English)
- > China, mainland 4001 200 951 (Mandarin/English)
- > India 000 800 4402 951 (English)
- > USA 1-866 951 9519 (English/German)
- > Other countries 00* 800 951 951 951 (English/German)
- > Direct access +49 89 234-0 (interconnection fee, German/English)

* Please note: Some countries may require you to dial a code other than "00" to access this international number.
Please visit www.infineon.com/service for your country!



Mobile product catalog

Mobile app for iOS and Android.

www.infineon.com

Published by
Infineon Technologies AG
81726 Munich, Germany

© 2016 Infineon Technologies AG.
All rights reserved.

Order number: B131-I0146-V2-7600-EU-EC-P
Date: 12 / 2016

Please note!

THIS DOCUMENT IS FOR INFORMATION PURPOSES ONLY AND ANY INFORMATION GIVEN HEREIN SHALL IN NO EVENT BE REGARDED AS A WARRANTY, GUARANTEE OR DESCRIPTION OF ANY FUNCTIONALITY, CONDITIONS AND/OR QUALITY OF OUR PRODUCTS OR ANY SUITABILITY FOR A PARTICULAR PURPOSE. WITH REGARD TO THE TECHNICAL SPECIFICATIONS OF OUR PRODUCTS, WE KINDLY ASK YOU TO REFER TO THE RELEVANT PRODUCT DATA SHEETS PROVIDED BY US. OUR CUSTOMERS AND THEIR TECHNICAL DEPARTMENTS ARE REQUIRED TO EVALUATE THE SUITABILITY OF OUR PRODUCTS FOR THE INTENDED APPLICATION.

WE RESERVE THE RIGHT TO CHANGE THIS DOCUMENT AND/OR THE INFORMATION GIVEN HEREIN AT ANY TIME.

Additional information

For further information on technologies, our products, the application of our products, delivery terms and conditions and/or prices, please contact your nearest Infineon Technologies office (www.infineon.com).

Warnings

Due to technical requirements, our products may contain dangerous substances. For information on the types in question, please contact your nearest Infineon Technologies office.

Except as otherwise explicitly approved by us in a written document signed by authorized representatives of Infineon Technologies, our products may not be used in any life-endangering applications, including but not limited to medical, nuclear, military, life-critical or any other applications where a failure of the product or any consequences of the use thereof can result in personal injury.